

The logo for innodisk, featuring the word "innodisk" in white lowercase letters on a red rectangular background. A small red square is positioned at the top right corner of the main red rectangle.

innodisk

EMP2 SERIES

mPCIe to Serial COM

User Manual

Rev 1.3

Copyright Information

2005-2017 ©Innodisk Corporation. All Rights Reserved

Innodisk™ is trademark or registered trademark of Innodisk Corporation.

This document is subject to change and revision without notice. No part of this document may be reproduced in any form by any photographic, electronic, mechanical or other means, or used in any information storage and retrieval system, without prior written permission from Innodisk Corporation.

All other product and brand names in this document are trademarks or registered trademarks of their respective owners.

版權說明

2005-2017 ©宜鼎國際股份有限公司

Innodisk™ 是宜鼎國際股份有限公司之註冊商標。

本文件得不經通知即更改或修訂。本文件中出現任何文字敘述、文件格式、圖形、照片、方法及過程等內容，除另特別註明，版權均屬宜鼎國際股份有限公司所有，受到相關之智慧財產權保護法之保障。任何個人、法人或機構未經宜鼎國際股份有限公司的書面（包括電子文件）授權，不得以任何形式複製或引用本文件之全部或片段。

其他出現在本文件的品牌或產品乃歸屬原公司所有之商標或註冊。

Revision History

Revision	Date	Description
1.0	2015/10/21	Initial Release
1.1	2016/10/4	Add products of EMP2-X4S1& EMP2-X4S2
1.2	2017/05/31	Remove EMP2-X401
1.3	2017/11/30	<ol style="list-style-type: none">1. Add the product of EGP2-X4012. Add a NOTE of Windows embedded in section 1.1.

Table of Contents

Revision History	ii
Table of Contents	iii
Overview	1
1. Windows	2
1.1. Install Driver	2
1.2. Switch Mode by Software (for EMP2-X404/X801, EGP2-X401).....	4
1.3. Switch Mode by Hardware (for EMP2-X202/X402).....	6
1.4. Enable RS-485 checkbox for RS-485 Half Duplex Mode	6
2. Linux	7
2.1. Install Driver	7
2.2. Install EMP2 Mode-Control Tool.....	7
2.3. Switch Mode by Software (for EMP2-X404/X801, EPG2-X401).....	8
2.4. Switch Mode by Hardware (for EMP2-X202/X402).....	9
Contact us	10

Overview

This manual describes how to implement EMP2 mPCIe to serial COM cards of the following products.

Product No.	RS232	RS485HD	RS485FD	Switch Method
EMP2-X202	X	O	O	Hardware
EMP2-X402	X	O	O	Hardware
EMP2-X203	O	X	X	N/A
EMP2-X403	O	X	X	N/A
EMP2-X801	O	O	O	Software
EMP2-X404	O	O	O	Software
EMP2-X4S1	X	X	O	N/A
EMP2-X4S2	X	O	O	N/A
EGP2-X401	O	O	O	Software

Note: HD: Half Duplex, FD: Full Duplex

1. Windows

1.1. Install Driver

This section is applicable to ALL products.

Please notice that the driver name including “Adj” is for EMP2 -X404/X801 and EGP2-X401. The driver name including “Fixed” is for EMP2-X202/X203/X402/X403/X4S1/X4S2.

Double click the driver package to start. If driver is already existed in the OS, it will be removed automatically before installation.

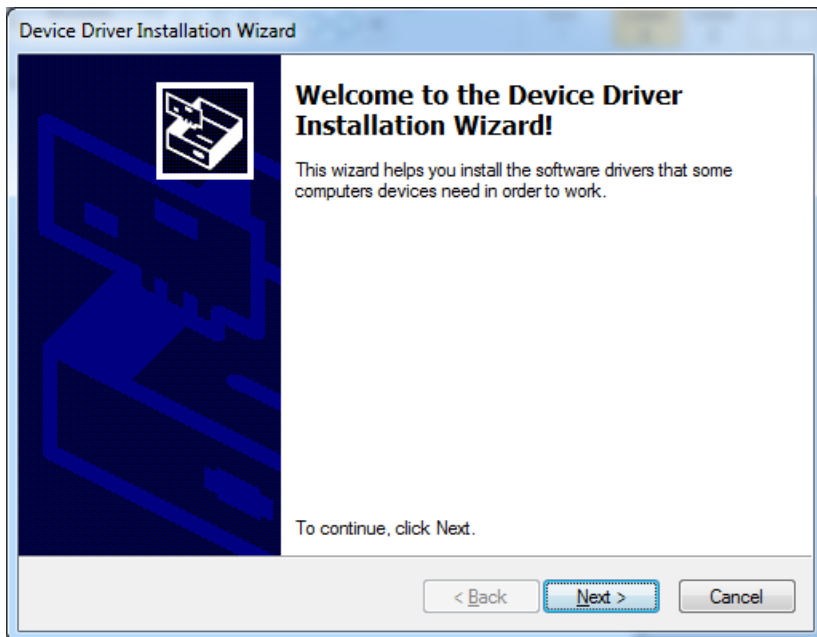
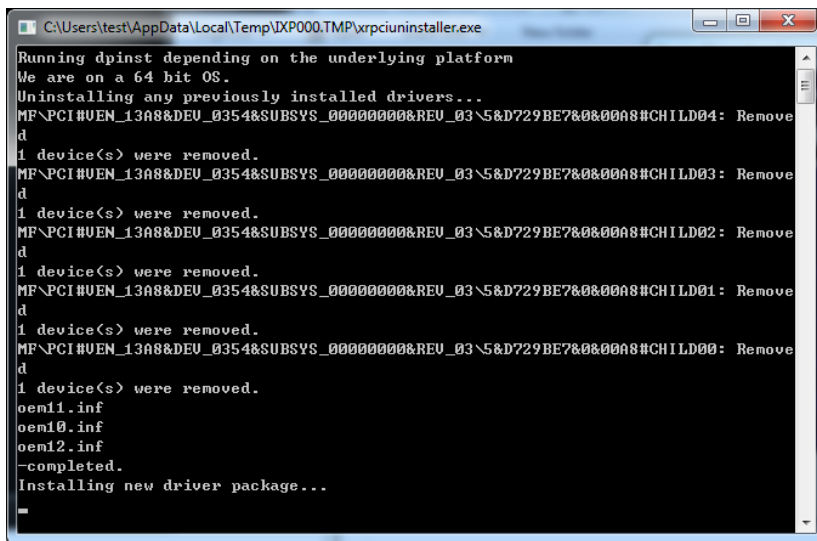

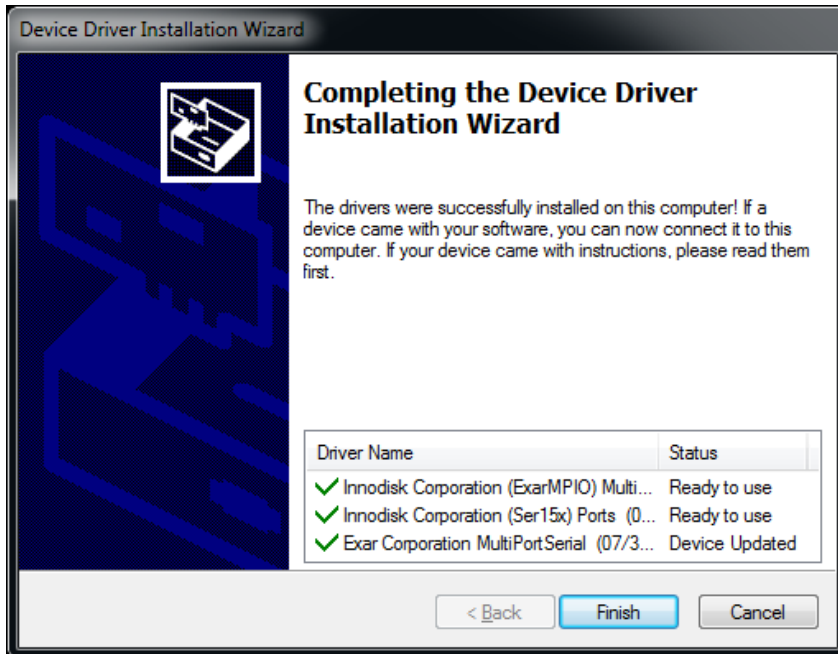
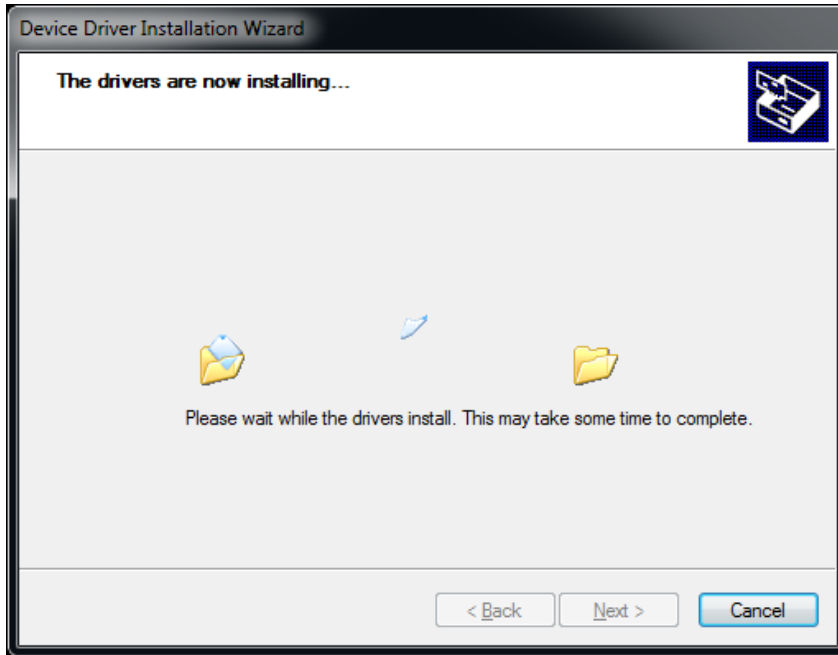

NOTE1: If you encounter an error while executing the driver, please download **“Microsoft Visual C++ Redistributable Package”** then install first.
<https://www.microsoft.com/en-us/download/details.aspx?id=29>

NOTE2: Please confirm Window Embedded has included “windows generic multifunction card driver” inbox driver.
 This package would be “WinEmb-INF-mf.cab”.
 You can add it by dism command online or WES ICE tool offline. Also you can modify the existed template directly to add mf driver section.

1.2. Switch Mode by Software (for EMP2-X404/X801, EGP2-X401)

This section is applicable to following products.

Product No.	RS232	RS485HD	RS485FD	Switch Method
EMP2-X404	○	○	○	Software
EMP2-X801	○	○	○	Software
EGP2-X401	○	○	○	Software

In Device Manager, right click the mouse to enter “properties” in **“InnodiskMPIO-Access Device”**.

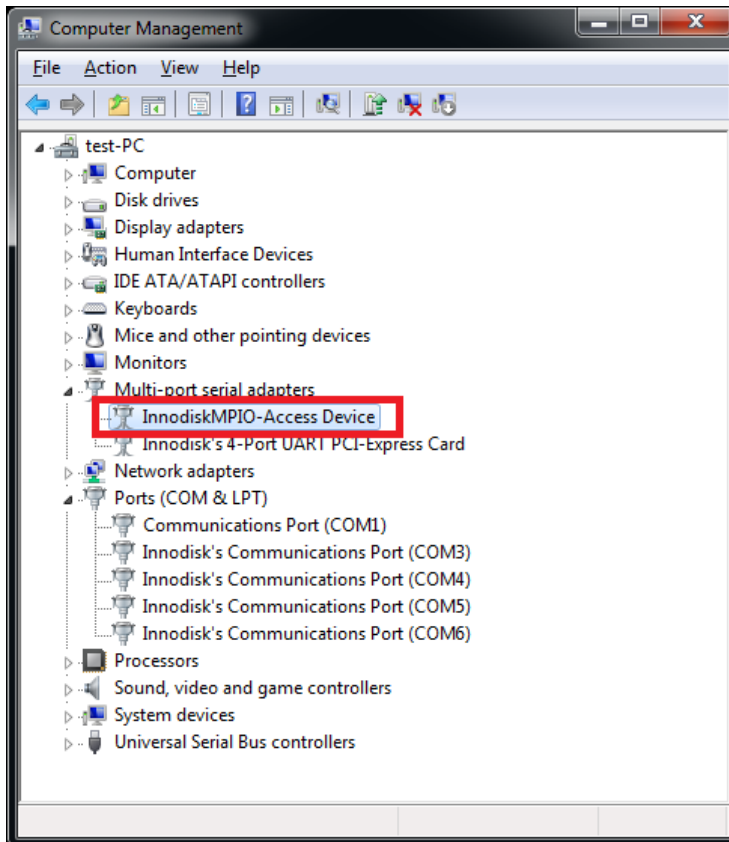

In “**COM Settings**”, you can select different mode among RS232, Loopback, RS485HD and RS485FD.

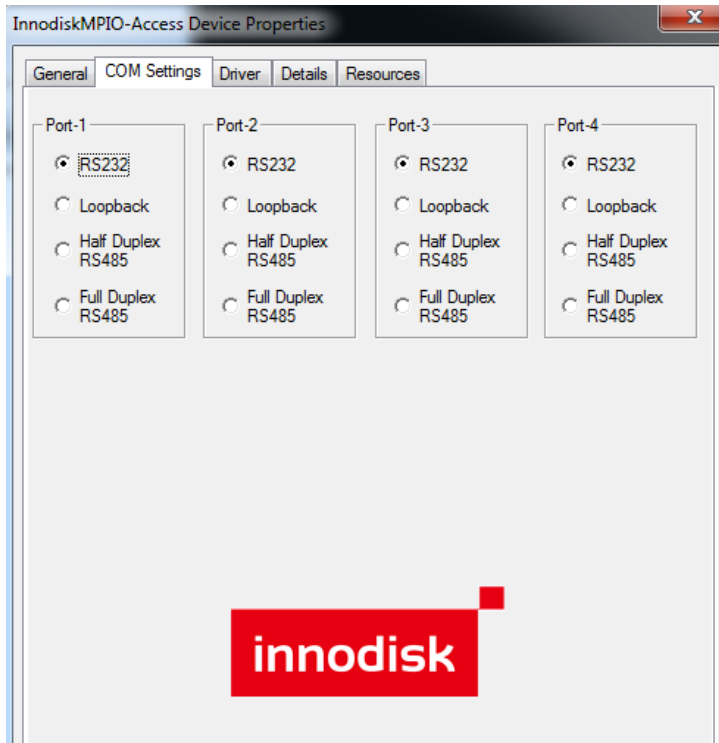

1.3. Switch Mode by Hardware (for EMP2-X202/X402)

This section is applicable to following products

Product No.	RS232	RS485HD	RS485FD	Switch Method
EMP2-X202	X	O	O	Hardware
EMP2-X402	X	O	O	Hardware

Switch mode between RS485 Half Duplex and Full Duplex by using DIP switch. Please refer to the following picture:

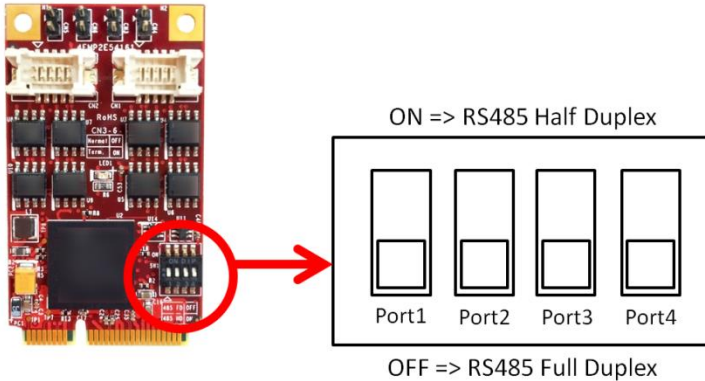

1.4. Enable RS-485 checkbox for RS-485 Half Duplex Mode

This section is applicable to ALL products.

In Device Manager, right click the mouse to enter “properties” in “**Innodisk’s Communications Port (COM“N”)**”. (“N” depends on the setting of real environment.)

In “**Port Settings**”, please check RS-485 checkbox when using RS-485 Half Duplex Mode

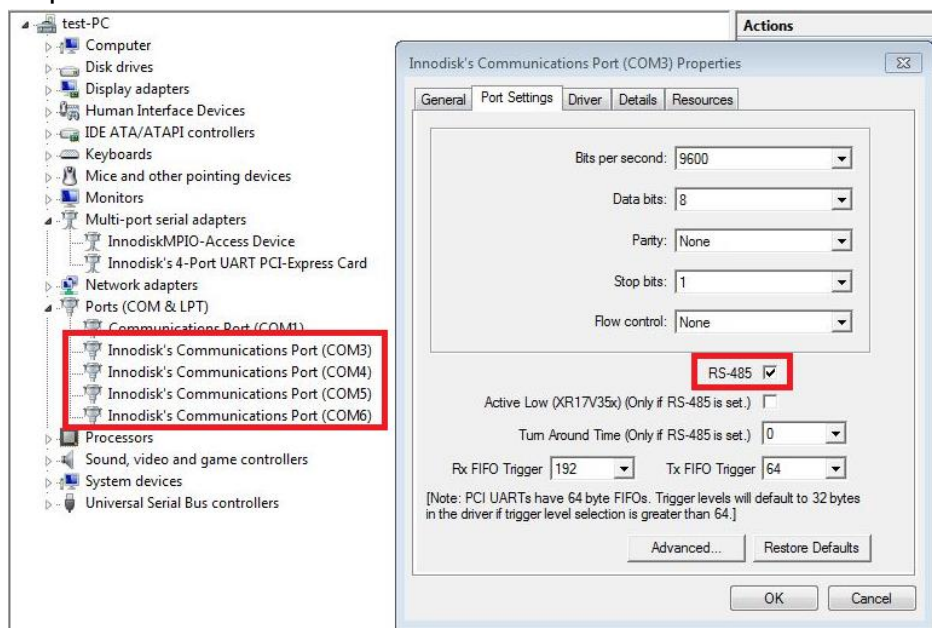

2. Linux

Here we use Ubuntu 14.04 for example.

2.1. Install Driver

This section is applicable to ALL products.

Step1. Go to driver folder.

Step2. Type command **“make”**.

Step3. Type command **“sudo make install”**

```
root@innodisk-System-Product-Name: /home/innodisk/emp2/driver
root@innodisk-System-Product-Name:/home/innodisk/emp2/driver# make
make -C /lib/modules/`uname -r`/build SUBDIRS=/home/innodisk/emp2/driver modules
make[1]: Entering directory `/usr/src/linux-headers-3.13.11.8-custom'
  CC [M] /home/innodisk/emp2/driver/xr17v35x.o
/home/innodisk/emp2/driver/xr17v35x.c: In function 'receive_chars':
/home/innodisk/emp2/driver/xr17v35x.c:558:21: warning: unused variable 'tty' [-Wunused-variable]
 struct tty_struct *tty = up->port.state->port.tty;
                   ^
Building modules, stage 2.
MODPOST 1 modules
  CC      /home/innodisk/emp2/driver/xr17v35x.mod.o
  LD [M]  /home/innodisk/emp2/driver/xr17v35x.ko
make[1]: Leaving directory `/usr/src/linux-headers-3.13.11.8-custom'
root@innodisk-System-Product-Name:/home/innodisk/emp2/driver# sudo make install
cp xr17v35x.ko /lib/modules/3.13.11.8-custom/kernel/drivers/char
depmod -a
root@innodisk-System-Product-Name:/home/innodisk/emp2/driver#
```

2.2. Install EMP2 Mode-Control Tool

This section is applicable to ALL products.

Step1. Go to tools folder.

Step2. Type command **“make”**.

Step3. Type command **“sudo make install”**

```
root@innodisk-System-Product-Name: /home/innodisk/emp2/tools
root@innodisk-System-Product-Name:/home/innodisk/emp2# cd tools
root@innodisk-System-Product-Name:/home/innodisk/emp2/tools# make
gcc regctl.c -o emp2reg
root@innodisk-System-Product-Name:/home/innodisk/emp2/tools# sudo make install
# clean old stuff in /sbin
if [ -f /sbin/emp2reg ]; then \
    rm -f /sbin/emp2*; \
fi
# install script and application
install -o 755 emp2cfg /usr/sbin/
install -o 755 emp2init /usr/sbin/
install -o 755 -s emp2reg /usr/sbin/
# install common definition items in /usr/lib/emp2
mkdir -p /usr/lib/emp2/
install -o 644 emp2lib /usr/lib/emp2/
root@innodisk-System-Product-Name:/home/innodisk/emp2/tools#
```

2.3. Switch Mode by Software (for EMP2-X404/X801, EPG2-X401)

This section is applicable to following products.

Product No.	RS232	RS485HD	RS485FD	Switch Method
EMP2-X404	○	○	○	Software
EMP2-X801	○	○	○	Software
EGP2-X401	○	○	○	Software

After installing driver and control tools, you can simply execute below command to initial EMP2 device.

Notice, all EMP2 control tools need to be executed as root.

- **COMMAND: `emp2init`**
The `emp2init` will help you check if the driver has been loaded on the system and setup all ports following the configuration file (`/etc/emp2.cfg`). If the configuration file did not exist, it will create a default one for you, all ports will be configured as RS232 mode by default.

Notice that, the `emp2init` must be executed after system boot up every time to make sure the driver loaded well and all ports be configured as you want.

- **COMMAND: `emp2cfg <port> <mode>`**
The `<port>` specify which port you want to configure, start from 1. And the `<mode>` specify the target mode, "lo" for LOOPBACK, "232" for RS-232, "485hd" for RS485 Half-Duplex, and "485fd" for RS-485 Full-Duplex.

```

root@innodisk-System-Product-Name: /
root@innodisk-System-Product-Name:/# emp2init
Found Exar device 0354 (4 ports)
Switch port 1 to mode 232 finished
Switch port 2 to mode 232 finished
Switch port 3 to mode 232 finished
Switch port 4 to mode 232 finished
root@innodisk-System-Product-Name:/# emp2cfg 1 lo
Switch port 1 to mode lo finished
root@innodisk-System-Product-Name:/# emp2cfg 2 232
Switch port 2 to mode 232 finished
root@innodisk-System-Product-Name:/# emp2cfg 3 485fd
Switch port 3 to mode 485fd finished
root@innodisk-System-Product-Name:/# emp2cfg 4 485hd
Switch port 4 to mode 485hd finished
root@innodisk-System-Product-Name:/# emp2init
Found Exar device 0354 (4 ports)
Switch port 1 to mode lo finished
Switch port 2 to mode 232 finished
Switch port 3 to mode 485fd finished
Switch port 4 to mode 485hd finished
root@innodisk-System-Product-Name:/#

```

- **COMMAND:** `emp2init reset`
Reset all port to default mode RS232.

```

root@innodisk-System-Product-Name: /
root@innodisk-System-Product-Name: /# emp2init reset
Found Exar device 0354 (4 ports)
Reset EMP2 configuration
Switch port 1 to mode 232 finished
Switch port 2 to mode 232 finished
Switch port 3 to mode 232 finished
Switch port 4 to mode 232 finished
root@innodisk-System-Product-Name: /# cat /etc/emp2.cfg
#
# generated by emp2init, don't modify it
# you can reset the configuration file by execute "emp2init reset"
#
PORTS=4
PORT1FIX=no
PORT1MODE=232
PORT2FIX=no
PORT2MODE=232
PORT3FIX=no
PORT3MODE=232
PORT4FIX=no
PORT4MODE=232
root@innodisk-System-Product-Name: /# █

```

2.4. Switch Mode by Hardware (for EMP2-X202/X402)

Please follow instructions in [1.3. Switch Mode by Hardware](#) to configure DIP switch.

This section is applicable to following products.

Product No.	RS232	RS485HD	RS485FD	Switch Method
EMP2-X202	X	O	O	Hardware
EMP2-X402	X	O	O	Hardware

After changing DIP switch between RS485HD and RS485FD, you need to execute the command `emp2init reset` to take effect, then you can also check the configuration file (`/etc/emp2.cfg`) to make sure it is in the correct mode.

Notice, all EMP2 control tools need to be executed as root.

```

root@innodisk-System-Product-Name: /home/innodisk
root@innodisk-System-Product-Name: /home/innodisk# emp2init reset
Found Exar device 0354 (4 ports)
Reset EMP2 configuration
root@innodisk-System-Product-Name: /home/innodisk# cat /etc/emp2.cfg
#
# generated by emp2init, don't modify it
# you can reset the configuration file by execute "emp2init reset"
#
PORTS=4
PORT1FIX=yes
PORT1MODE=485hd
PORT2FIX=yes
PORT2MODE=485hd
PORT3FIX=yes
PORT3MODE=485fd
PORT4FIX=yes
PORT4MODE=485fd
root@innodisk-System-Product-Name: /home/innodisk# █

```

Contact us

Headquarters (Taiwan)

5F., No. 237, Sec. 1, Datong Rd., Xizhi Dist., New Taipei City 221, Taiwan

Tel: +886-2-77033000

Email: sales@innodisk.com

Branch Offices:

USA

usasales@innodisk.com

+1-510-770-9421

Europe

eusales@innodisk.com

+31-40-3045-4008

Japan

jpsales@innodisk.com

+81-3-6667-0161

China

sales_cn@innodisk.com

+86-755-2167-3689

www.innodisk.com

© 2017 Innodisk Corporation.

All right reserved. Specifications are subject to change without prior notice.

November 30, 2017