



Connect Tech Inc.

Embedded Computing Experts

www.connecttech.com

Mini PCIe GbE Users Guide

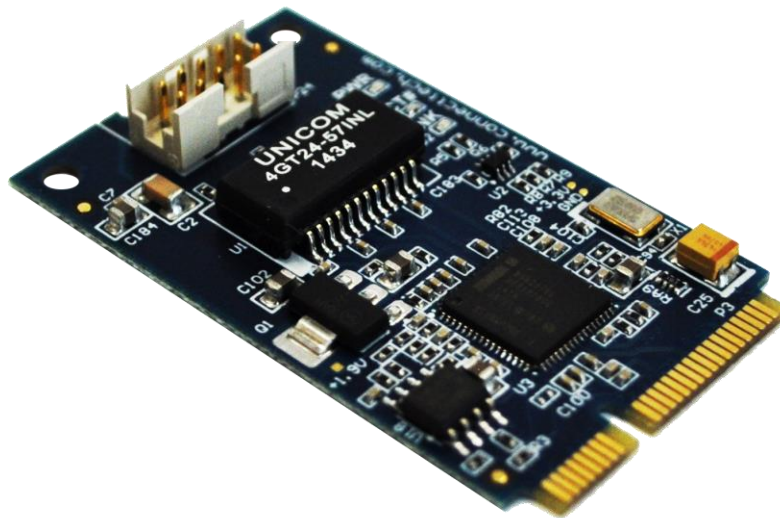

Connect Tech Inc.

42 Arrow Road
Guelph, Ontario
N1K 1S6

www.connecttech.com

Tel: 519-836-1291

Toll: 800-426-8979 (North America only)

Fax: 519-836-4878

Email: sales@connecttech.com
support@connecttech.com

Table of Contents

Table of Contents	2
Preface	3
Disclaimer	3
Customer Support Overview	3
Contact Information	3
Limited Mini PCIe GbE Warranty	4
Copyright Notice	4
Trademark Acknowledgment	4
ESD Warning	5
Revision History	5
Introduction	6
Product Features and Specifications	6
Part Numbers / Ordering Information	6
Product Overview	7
Block Diagram	7
Connector Summary & Locations	7
Interface Pin-outs	8
Mini PCIe Edge Connector	8
10/100/1000 Ethernet (GbE) Connector	9
Detailed Feature Description	10
PCI Express Interface	10
10/100/1000Base-T Port.....	10
SMBus Management Port	10
Software Support for the Intel 82574	10
On-board Indicator LEDs	11
Cables	12
RJ-45 panel mount to 10-pin MiniTek w/Latch - CBG117.....	12
Right Angle Connector Interference	13

Preface

Disclaimer

The information contained within this user's guide, including but not limited to any product specification, is subject to change without notice.

Connect Tech assumes no liability for any damages incurred directly or indirectly from any technical or typographical errors or omissions contained herein or for discrepancies between the product and the user's guide.

Customer Support Overview

If you experience difficulties after reading the manual and/or using the product, contact the Connect Tech reseller from which you purchased the product. In most cases the reseller can help you with product installation and difficulties.

In the event that the reseller is unable to resolve your problem, our highly qualified support staff can assist you. Our support section is available 24 hours a day, 7 days a week on our website at: www.connecttech.com/sub/support/support.asp. See the contact information section below for more information on how to contact us directly. Our technical support is always free.

Contact Information

Mail/Courier

Connect Tech Inc.
Technical Support
42 Arrow Road
Guelph, Ontario
Canada N1K 1S6

Email/Internet

sales@connecttech.com
support@connecttech.com
www.connecttech.com

Note:

Please go to the [Download Zone](#) or the [Knowledge Database](#) in the [Support Center](#) on the Connect Tech website for product manuals, installation guides, device driver software and technical tips. Submit your technical support questions to our customer support engineers via the [Support Center](#) on the Connect Tech website.

Telephone/Facsimile

Technical Support representatives are ready to answer your call Monday through Friday, from 8:30 a.m. to 5:00 p.m. Eastern Standard Time. Our numbers for calls are:

Toll Free: 800-426-8979 (North America only)

Telephone: 519-836-1291 (Live assistance available 8:30 a.m. to 5:00 p.m. EST, Monday to Friday)

Facsimile: 519-836-4878 (on-line 24 hours)



Limited Mini PCIe GbE Warranty

Connect Tech Inc. provides a 2-Year Warranty for the Mini PCIe GbE. Should this product, in Connect Tech Inc.'s opinion, fail to be in good working order during the warranty period, Connect Tech Inc. will, at its option, repair or replace this product at no charge, provided that the product has not been subjected to abuse, misuse, accident, disaster or non-Connect Tech Inc. authorized modification or repair.

You may obtain warranty service by delivering this product to an authorized Connect Tech Inc. business partner or to Connect Tech Inc. along with proof of purchase. Product returned to Connect Tech Inc. must be pre-authorized by Connect Tech Inc. with an RMA (Return Material Authorization) number marked on the outside of the package and sent prepaid, insured and packaged for safe shipment. Connect Tech Inc. will return this product by prepaid ground shipment service.

The Connect Tech Inc. 2-Year Warranty is only valid over the serviceable life of the product. This is defined as the period during which all components are available. Should the product prove to be irreparable, Connect Tech Inc. reserves the right to substitute an equivalent product if available or to retract the 2-Year Warranty if no replacement is available.

The above warranty is the only warranty authorized by Connect Tech Inc. Under no circumstances will Connect Tech Inc. be liable in any way for any damages, including any lost profits, lost savings or other incidental or consequential damages arising out of the use of, or inability to use, such product.

Copyright Notice

The information contained in this document is subject to change without notice. Connect Tech Inc. shall not be liable for errors contained herein or for incidental consequential damages in connection with the furnishing, performance, or use of this material. This document contains proprietary information that is protected by copyright. All rights are reserved. No part of this document may be photocopied, reproduced, or translated to another language without the prior written consent of Connect Tech, Inc.

Copyright © 2014 by Connect Tech, Inc.

Trademark Acknowledgment

Connect Tech, Inc. acknowledges all trademarks, registered trademarks and/or copyrights referred to in this document as the property of their respective owners. Not listing all possible trademarks or copyright acknowledgments does not constitute a lack of acknowledgment to the rightful owners of the trademarks and copyrights mentioned in this document.

ESD Warning



Electronic components and circuits are sensitive to ElectroStatic Discharge (ESD). When handling any circuit board assemblies including Connect Tech COM Express carrier assemblies, it is recommended that ESD safety precautions be observed. ESD safe best practices include, but are not limited to:

- Leaving circuit boards in their antistatic packaging until they are ready to be installed.
- Using a grounded wrist strap when handling circuit boards, at a minimum you should touch a grounded metal object to dissipate any static charge that may be present on you.
- Only handling circuit boards in ESD safe areas, which may include ESD floor and table mats, wrist strap stations and ESD safe lab coats.
- Avoiding handling circuit boards in carpeted areas.
- Try to handle the board by the edges, avoiding contact with components.

Revision History

Revision	Date	Changes
0.00	2014-09-09	Preliminary Release
0.01	2014-09-23	Added images of Right Angle Mating Interference

Introduction

Connect Tech's MPG100 series boards are rugged, low cost Gigabit Ethernet Mini PCIe modules that are ideal for adding extra Ethernet capabilities to any system with minimal increase in overall system size and power consumption.

The modules utilize PCIe signaling which allows it to be used in any Mini PCIe socket that supports PCIe. The wide operating temperature, latching Ethernet connector and cabling solution allows these modules to be used in harsh environments.

Compatibility with a large variety of popular operating systems allows these boards to be easily integrated into a wide array of new and existing systems.

Product Features and Specifications

Specifications	
Dimensions	50.95 mm x 30 mm, Mini PCIe "Full" form factor
10/100/1000BASE-T Ports	1
Connector	Mini Tek, 2mm, 2x5, Right Angle (MPG101) Mini Tek, 2mm, 2x5, Vertical (MPG102)
Cables	CBG117
Environmental	-40° C to 85° C, Humidity: 5 to 95% non-condensing
Status LEDs	LINK#, ACTIVITY#, POWER OK

Part Numbers / Ordering Information

Part Number	
MPG101	10/100/1000BASE-T, Right-Angle Network Connector, -40° C to 85° C, ROHS
MPG102	10/100/1000BASE-T, Vertical Network Connector, -40° C to 85° C, ROHS

Product Overview

Block Diagram

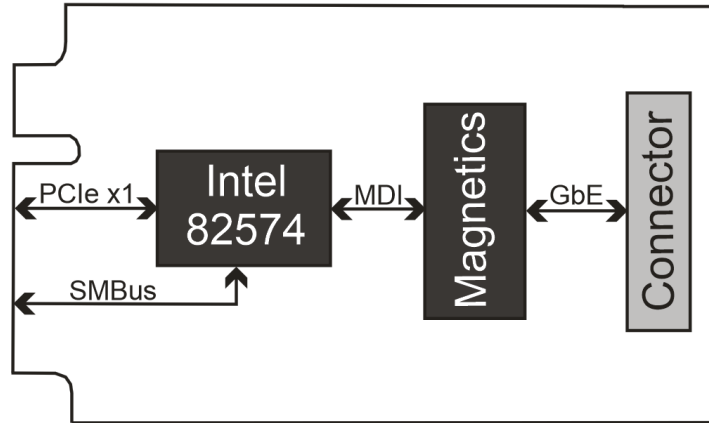

Connector Summary & Locations

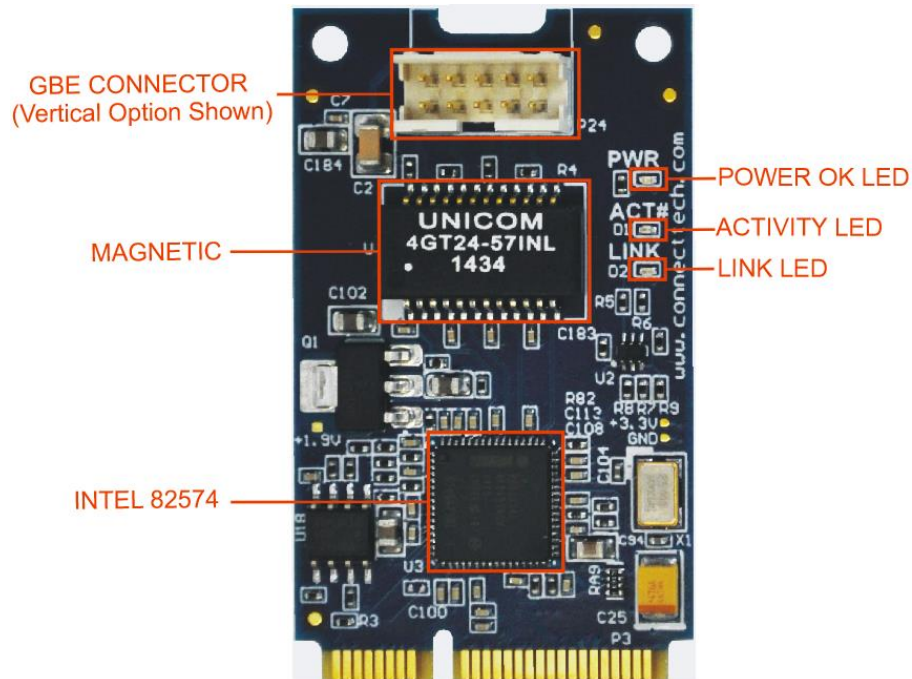

Interface Pin-outs

Mini PCIe Edge Connector

The Mini PCIe GbE pin-out is compliant to the PCI Express Mini Card Electromechanical Specification Rev. 2.0. Please note that this module does not require the +1.5V power provided to a standard Mini PCIe connector. This module uses only +3.3V for input power. This module does not connect the Display Port or USB pins on the Mini PCIe connector.

Function	Mini PCIe Card Edge Connector			
Location	P3			
Pinout	Signal	Pin	Pin	Signal
		WAKE#	1	2
	NC	3	4	GND
	NC	5	6	NC
	NC	7	8	NC
	GND	9	10	NC
	REFCLK-	11	12	NC
	REFCLK+	13	14	NC
	GND	15	16	NC
	NC	17	18	GND
	NC	19	20	NC
	GND	21	22	PEREST#
	PER- <small>(from this module to system)</small>	23	24	+3.3V
	PER+ <small>(from this module to system)</small>	25	26	GND
	GND	27	28	NC
	GND	29	30	SMBus_CLK
	PET- <small>(from system to this module)</small>	31	32	SMBus_DATA
	PET+ <small>(from system to this module)</small>	33	34	GND
	GND	35	36	NC
	GND	37	38	NC
	+3.3V	39	40	GND
	+3.3V	41	42	NC
	GND	43	44	NC
	NC	45	46	NC
	NC	47	48	NC
	NC	49	50	GND
	NC	51	52	+3.3V



10/100/1000 Ethernet (GbE) Connector

Function	LAN Connector		
Location	P24		
Connector PN	MPG101: 98464-G61-10ULF - Manufacturer: FCI MPG102: 98414-G06-10LF - Manufacturer: FCI		
Mating Connector PN	10073599-010LF - Manufacturer: FCI		
Pinout	Pin	Signal	Description
	1	MX1-	Ethernet Pair 1
	2	MX1+	Ethernet Pair 1
	3	MX2-	Ethernet Pair 2
	4	MX2+	Ethernet Pair 2
	5	SHELL	RJ Shell Connection
	6	SHELL	RJ Shell Connection
	7	MX3-	Ethernet Pair 3
	8	MX3+	Ethernet Pair 3
	9	MX4-	Ethernet Pair 4
	10	MX4+	Ethernet Pair 4

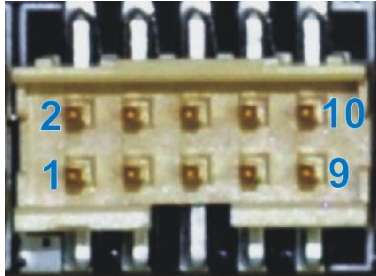

98414-G06-10LF shown

Detailed Feature Description

PCI Express Interface

The Mini PCIe Gbe supports one PCIe Rev. 1.1 lane connecting between the Mini PCIe edge fingers and the Intel 82574 GbE controller. This interface has sufficient bandwidth to support 1000 Mb/s transfer rate and with 40 KB of on-board buffering, mitigates instantaneous receive bandwidth stresses and eliminates transmit delays by buffering the outgoing packet prior to transmission.

10/100/1000Base-T Port

The Mini PCIe GbE supports one Ethernet interface port supporting 1000BASE-T, 100BASE-TX, and 10BASE-T (IEEE 802.3, 802.3u, 802.3ab). This multi-speed port can operate in Half or Full duplex and includes flow control support compliant with IEEE 802.3X as well as VLAN support compliant with IEEE 802.3q. Note that half-duplex 1000 MB/s operation is not supported.

SMBus Management Port

The SMBus interface allows software-based network management by providing a mechanism by which network traffic can be routed to and from a Management Controller. The SMBus supports pass-through capabilities, with the following filtering options:

- RMCP/RMCP+ ports
- Flexible UDP/TCP port filters
- 128-byte flexible filters
- VLAN
- IPv4 address
- IPv6 address
- MAC address filters

Using the SMBus pass-through interface, a received packet can be discarded, sent to host memory, sent to an external management controller, or both host memory and external management controller. All manageability filters are controlled by the management controller, not the 82574 drivers.

Software Support for the Intel 82574

Additional drivers will be needed to properly operate the GBE Port.

These drivers can be downloaded directly from Intel website from the below link:

<https://downloadcenter.intel.com/SearchResult.aspx?lang=eng&ProductID=3023&ProdId=3023>

On-board Indicator LEDs

The Mini PCIe GbE has three onboard LEDs that are clearly labeled on the PCB.

LED	Description
D1	Activity Indicator; Illuminates when traffic is being transferred over the LAN port.
D2	Link Indicator; When illuminated indicates 1000BASE-T channel bandwidth
D3	Power OK Indicator; When illuminated indicates +3.3V to the Mini PCIe GbE module is within specification

Cables

RJ-45 panel mount to 10-pin MiniTek w/Latch - CBG117



RJ45 (8P8C)	Signal	10-pin MiniTek
1	MX1-	1
2	MX1+	2
3	MX2-	3
4	MX2+	4
SHELL	SHELL	5
SHELL	SHELL	6
7	MX3-	7
8	MX3+	8
9	MX4-	9
10	MX4+	10

Right Angle Connector Interference

When using the right angle Mini PCIe GbE (MPG101), there is mating interference between the Mini PCIe latch and the latch on the network cable CBG117. This interference will not allow the cable to securely latch to the GbE connector. Please see images below.

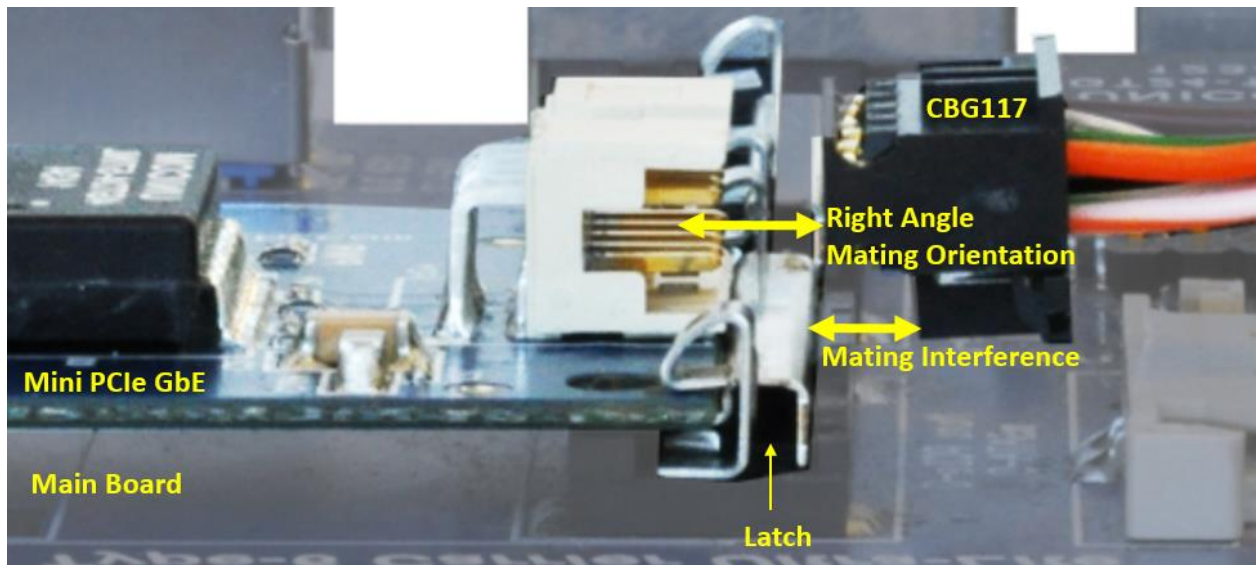
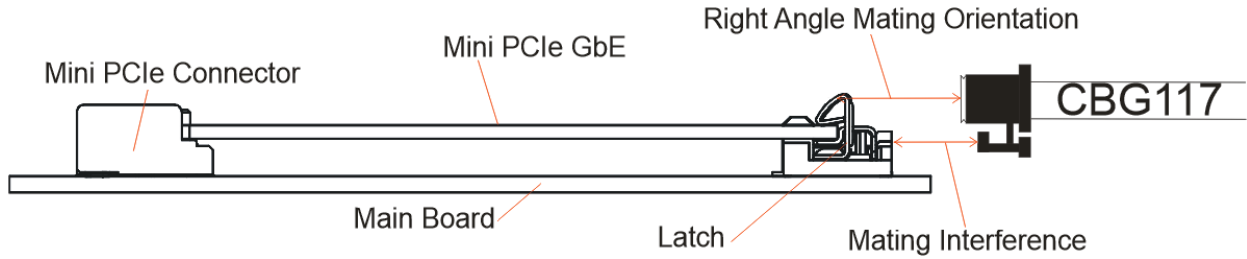

Therefore, if your application requires the right angle connector option (MPG101), CTI suggests using stand-offs and screws to secure the Mini PCIe module to the main board, not a latch as shown above.