

# ECR

## Installation and User Manual

---





Copyright © March 2019 INSYS MICROELECTRONICS GmbH

Any duplication of this manual is prohibited. All rights on this documentation and the devices are with INSYS MICROELECTRONICS GmbH Regensburg.

#### Trademarks

The use of a trademark not shown below is not an indication that it is freely available for use.

MNP is a registered trademark of Microcom Inc.

IBM PC, AT, XT are registered trademarks of International Business Machine Corporation.

INSYS®, VCom®, e-Mobility LSG® and e-Mobility PLC® are registered trademarks of INSYS MICROELECTRONICS GmbH.

Windows™ is a registered trademark of Microsoft Corporation.

Linux is a registered trademark of Linus Torvalds.

#### Publisher:

INSYS MICROELECTRONICS GmbH

Hermann-Köhl-Str. 22

D-93049 Regensburg, Germany

Phone: +49 941 58692 0

Fax: +49 941 58692 45

E-mail: [info@insys-icom.com](mailto:info@insys-icom.com)

Internet: <http://www.insys-icom.com>

Date: Mar-19

Item: 10021496

Version: 1.0

Language: EN

<b>1</b>	<b>Preface</b> .....	<b>6</b>
1.1	Defects Liability Terms.....	6
1.2	Feedback.....	6
1.3	Marking of Warnings and Notes.....	7
1.4	Symbols and the Formatting in this Manual.....	8
<b>2</b>	<b>Safety</b> .....	<b>9</b>
2.1	Intended Use.....	9
2.2	Permissible Technical Limits.....	10
2.3	Responsibilities of the Operator.....	10
2.4	Qualification of the Personnel.....	10
2.5	Instructions for Transport and Storage.....	10
2.6	Markings on the Product.....	11
2.7	Environmental Protection.....	11
2.8	Safety Instructions for Electrical Installation.....	12
2.9	General Safety Instructions.....	13
<b>3</b>	<b>Using Open Source Software</b> .....	<b>15</b>
3.1	General Information.....	15
3.2	Special Liability Regulations.....	16
3.3	Used Open-Source Software.....	16
<b>4</b>	<b>Version History</b> .....	<b>17</b>
<b>5</b>	<b>Device Variants</b> .....	<b>18</b>
<b>6</b>	<b>Scope of Delivery</b> .....	<b>19</b>
<b>7</b>	<b>Technical Information</b> .....	<b>20</b>
7.1	Technical Data.....	20
7.1.1	Physical Features.....	20
7.1.2	Technological Features.....	22
7.2	Connections, display and control elements.....	23
7.3	Power supply.....	26
7.4	Inputs and Outputs.....	26
7.4.1	Digital inputs.....	26
7.4.2	Digital outputs.....	26
7.5	RS232 interface.....	27
7.6	RS485 interface.....	27
7.7	Connecting the connectors.....	28
7.8	Maximum line lengths.....	28

---

<b>8</b>	<b>Assembly .....</b>	<b>29</b>
8.1	Screw mounting .....	30
8.2	DIN rail mounting .....	31
8.3	Connecting the power supply .....	32
<b>9</b>	<b>Commissioning .....</b>	<b>33</b>
<b>10</b>	<b>Operating Principle.....</b>	<b>36</b>
10.1	Operation via the web interface .....	36
10.2	Access via HTTPS Protocol .....	38
10.2.1	Authentication via the device-individual certificate/key combination ....	38
10.2.2	Authentication via an own certificate structure.....	39
10.3	Profiles and Profile Handling.....	40
10.3.1	Term definitions .....	40
10.3.2	Working with one profile.....	40
10.3.3	Using several profiles .....	41
10.3.4	ASCII Configuration.....	42
<b>11</b>	<b>Maintenance, Repair and Troubleshooting .....</b>	<b>43</b>
11.1	Maintenance.....	43
11.2	Troubleshooting.....	43
11.3	Repair	43
<b>12</b>	<b>Waste Disposal.....</b>	<b>44</b>
12.1	Repurchasing of Legacy Systems.....	44
<b>13</b>	<b>Declaration of Conformity .....</b>	<b>45</b>
<b>14</b>	<b>Export Restriction .....</b>	<b>46</b>
<b>15</b>	<b>Glossary.....</b>	<b>47</b>
<b>16</b>	<b>Tables and Diagrams .....</b>	<b>51</b>
16.1	List of Tables .....	51
16.2	List of Diagrams.....	51
<b>17</b>	<b>Index .....</b>	<b>52</b>

# 1 Preface

This manual allows for the safe and efficient use of the product. The manual is part of the product and must always be stored accessible for installation, commissioning and operating personnel.

## 1.1 Defects Liability Terms

A usage not according to the intended purpose, an ignorance of this documentation, the use of insufficiently qualified personnel as well as unauthorised modifications exclude the liability of the manufacturer for damages resulting from this. The liability of the manufacturer ceases to exist.

The regulations of our Delivery and Purchasing Conditions are effective. These can be found on our website ([www.insys-icom.de/imprint/](http://www.insys-icom.de/imprint/)) under "General Terms and Conditions".

## 1.2 Feedback

We are permanently improving our products and the associated technical documentation. Your feedback is very helpful for this. Please tell us what you like in particular on our products and publications and what can be improved from your point of view. We highly appreciate your suggestions and will include them in our work to support you and all our customers. We are looking forward to any of your feedback.

Please send an e-mail to [support@insys-tec.de](mailto:support@insys-tec.de).

We'd like to know your applications. Please send us a few headwords that we know the applications you solve using products of INSYS icom.

## 1.3 Marking of Warnings and Notes

### Symbols and Key Words

#### **Danger!**



##### **Risk of severe or fatal injury**

One of these symbols in conjunction with the key word Danger indicates an imminent danger. It will cause death or severe injuries if not avoided.



#### **Warning!**



##### **Personal injury**

This symbol in conjunction with the key word Warning indicates a possibly hazardous situation. It might cause death or severe injuries if not avoided.

#### **Caution!**



##### **Slight injury and / or material damage**

This symbol in conjunction with the key word Caution indicates a possibly hazardous or harmful situation. It might cause slight or minor injuries or a damage of the product or something in its vicinity if not avoided.

#### **Note**



##### **Improvement of the application**

This symbol in conjunction with the key word Note indicates hints for the user or very useful information. This information helps with installation, set-up and operation of the product to ensure a fault-free operation.

## 1.4 Symbols and the Formatting in this Manual

This section describes the definition, formatting and symbols used in this manual. The various symbols are meant to help you read and find the information relevant to you. The following text is structured like a typical operating instruction of this manual.

### **Bold print: This will tell you what the following steps will result in**

After that, there will be a detailed explanation why you could perform the following steps to be able to reach the objective indicated first. You can decide whether the section is relevant for you or not.

→ An arrow will indicate prerequisites which must be fulfilled to be able to process the subsequent steps in a meaningful way. You will also learn which software or which equipment you will need.

### **1. *One individual action step: This tells you what you need to do at this point. The steps are numbered for better orientation.***

✓ A result which you will receive after performing a step will be marked with a check mark. At this point, you can check if the previous steps were successful.

ⓘ Additional information which you should consider are marked with a circled "i". At this point, we will indicate possible error sources and tell you how to avoid them.

➤ *Alternative results and steps are marked with an arrow. This will tell you how to reach the same results performing different steps, or what you could do if you didn't reach the expected results at this point.*



## 2 Safety

The Safety section provides an overview about the safety instructions, which must be observed for the operation of the product.

The product is constructed according to the currently valid state-of-the-art technology and reliable in operation. It has been checked and left the factory in flawless condition concerning safety. In order to maintain this condition during the service life, the instructions of the valid publications and certificates must be observed and followed.

It is necessary to adhere to the general safety instructions must when operating the product. The descriptions of processes and operation procedures are provided with precise safety instructions in the respective sections in addition to the general safety instructions.

Moreover, the local accident prevention regulations and general safety regulations for the operating conditions of the device are effective.

An optimum protection of the personnel and the environment from hazards as well as a safe and fault-free operation of the product is only possible if all safety instructions are observed.

### 2.1 Intended Use

The product may be used for the following purposes:

- Usage and mounting in an industrial cabinet.
- Switching and data transmission functions in machines according to the machine directive 2006/42/EC.
- Usage as data transmission device for a PLC.

The product may not be used for the following purposes and used or operated under the following conditions:

- Controlling or switching of machines and systems, which do not comply with the directive 2006/42/EC.
- Usage, controlling, switching and data transmission of machines and systems, which are operated in explosive atmospheres.
- Controlling, switching and data transmission of machines, which may involve risks to life and limb due to their functions or when a breakdown occurs.

## 2.2 Permissible Technical Limits

The product is only intended for the use within the permissible technical limits specified in the data sheets.

The following permissible limits must be observed:

- The ambient temperature limits must not be fallen below or exceeded.
- The supply voltage range must not be fallen below or exceeded.
- The maximum humidity must not be exceeded and condensate formation must be prevented.
- The maximum switching voltage and the maximum switching current load must not be exceeded.
- The maximum input voltage and the maximum input current must not be exceeded.

## 2.3 Responsibilities of the Operator

As a matter of principle, the operator must observe the legal regulations, which are valid in his country, concerning operation, functional test, repair and maintenance of electrical devices.

## 2.4 Qualification of the Personnel

The installation, commissioning and maintenance of the product must only be performed by trained expert personnel, which has been authorised by the plant operator. The expert personnel must have read and understood this documentation and observe the instructions.

Electrical connection and commissioning must only be performed by a person, who is able to work on electrical installations and identify and avoid possible hazards independently, based on professional training, knowledge and experience as well as knowledge of the relevant standards and regulations.

## 2.5 Instructions for Transport and Storage

The following instructions must be observed:

- Do not expose the product to moisture and other potential hazardous environmental conditions (radiation, gases, etc.) during transport and storage. Pack product accordingly.
- Pack product sufficiently to protect it against shocks during transport and storage, e.g. using air-cushioned packing material.

Check product for possible damages, which might have been caused by improper transport, before installation. Transport damages must be noted down to the shipping documents. All claims or damages must be filed immediately and before installation against the carrier or party responsible for the storage.

## 2.6 Markings on the Product

The identification plate of the product is either a print or a label on a face of the product. Amongst other things, it can contain the following markings, which are explained in detail here.



### Observe manual

This symbol indicates that the manual of the product contains essential safety instructions that must be followed implicitly.



### Dispose waste electronic equipment environmentally compatible

This symbol indicates that waste electronic equipment must be disposed separately from residual waste via appropriate collecting points. See also Section Disposal in this manual.



### CE marking

By applying a CE marking, the manufacturer confirms that the product complies with the European directives that apply product-specific.



### UL marking

By applying a UL marking, the manufacturer confirms that the product complies with the obligatory safety requirements.



### Appliance Class II - double insulated

This symbol indicates that the product complies with Appliance Class II



### Appliance Class III - protection by extra low voltage

This symbol indicates that the product complies with Appliance Class III

## 2.7 Environmental Protection

Dispose the product and the packaging according to the relevant environmental protection regulations. The Waste Disposal section in this manual contains notes about disposing the product. Separate the packaging components of cardboard and paper as well as plastic and deliver them to the respective collection systems for recycling.

## 2.8 Safety Instructions for Electrical Installation

The electrical connection must only be made by authorised expert personnel according to the wiring diagrams.

The notes to the electrical connection in the manual must be observed. Otherwise, the protection category might be affected.

The safe disconnection of circuits, which are hazardous when touched, is only ensured if the connected devices meet the requirements of VDE T.101 (Basic requirements for safe disconnection).

The supply lines are to be routed apart from circuits, which are hazardous when touched, or isolated additionally for a safe disconnection.

An easily accessible isolation device that disconnects all lines must be installed prior to commissioning of the device to be able to isolate it completely from power supply.

## 2.9 General Safety Instructions

### Caution!



**Electrostatic discharges may damage the product!**

**Damage of the product.**

Observe the general safety precautions when handling electrostatic-discharge-sensitive parts.

### Caution!



**Incomplete voltage isolation!**

**Damage of the product.**

To isolate the voltage from the device, disconnect **any** supply circuit with its respective isolation device if a redundant power supply is used.

### Caution!



**Overvoltage in power supply!**

**Fire hazard and damage of the product.**

The product must be secured with a suitable fuse against currents exceeding 6.3 A. It must be ensured that the fuse will only be replaced by a fuse with the same rating in case it needs to be replaced.

### Caution!



**Moisture and liquids from the environment may seep into the interior of the product!**

**Fire hazard and damage of the product.**

The product must not be used in wet or damp environments, or in the direct vicinity of water. Install the product at a dry location, protected from water spray. Disconnect the power supply before you perform any work on a device which may have been in contact with moisture.

**Caution!**

**Short circuits and damage due to improper repairs and modifications as well as opening of maintenance areas!**

**Fire hazard and damage of the product.**

It is not permitted to open the product for repair or modification exceeding the removal or installation of the designated plug-in cards.

**Caution!**

**Overvoltage and voltage peaks from the mains supply!**

**Fire hazard and damage of the product due to overvoltage.**

Install suitable overvoltage protection.

**Caution!**

**Damage due to chemicals!**

**Ketones and chlorinated hydrocarbons dissolve the plastic housing and damage the surface of the device.**

Never let the device come into contact with ketones (e.g. acetone) or chlorinated hydrocarbons, such as dichloromethane.

**Caution!**

**Distance from antennas to persons!**

**A too low distance from cellular antennas to persons can affect the health.**

Please observe to keep a minimum distance of 20 cm between the cellular antenna and persons during operation.

- ❗ Important note for installations in Sweden or Norway:  
Utrustning som är kopplad till skyddsjord via jordat vägguttag och/eller via annan utrustning och samtidigt är kopplad till kabel-TV nät kan i vissa fall medföra risk fr brand. För att undvika detta skall vid anslutning av utrustningen till kabel-TV nät galvanisk isolator finnas mellan utrustningen och kabel-TV nätet.

## 3 Using Open Source Software

### 3.1 General Information

This product contains, amongst others, so-called open-source software that is provided by third parties and has been published for free public use. The open-source software is subject to special open-source software licenses and the copyright of third parties. Basically, each customer can use the open-source software freely in compliance with the licensing terms of the respective producers. The rights of the customer to use the open-source software beyond the purpose of our product are regulated in detail by the respective concerned open-source software licenses. The customer use the open-source software freely, as provided in the respective effective license, beyond the purpose that the open-source software gets in our product. In case there is a contradiction between the licensing terms for our product and the respective open-source software license, the respective relevant open-source software license takes priority over our licensing terms, as far as the respective open-source software is concerned by this.

The use of the used open-source software is possible free of charge. We do not demand usage fees or any comparable fees for the use of the open-source software contained in our product. The use of the open-source software in our product by the customer is not part of the earnings we achieve with the contractual compensation.

All open-source software programs contained in our product can be taken from the available list. The most important open-source software licenses are listed in the Licenses section at the end of this publication.

As far as programs contained in our product are subject to the GNU General Public License (GPL), GNU Lesser General Public License (LGPL), Clarified Artistic License or another open-source software license, which regulates that the source code must be made available, and if this software is not already delivered in source code on a data carrier with our product, we will send you this at any time upon request. If it is required to send this on a data carrier, the sending will be made against payment of a cost compensation of € 10,00. Our offer to send the source code upon request ceases automatically 3 years after delivery of our product to the customer. Requests must be directed to the following address, if possible under specification of the serial number:

INSYS MICROELECTRONICS GmbH

Hermann-Köhl-Str. 22

93049 Regensburg, Germany

Phone +49 941 58692 0

Fax +49 941 58692 45

E-mail: support@insys-icom.de

## 3.2 Special Liability Regulations

We do not assume any warranty or liability, if the open-source software programs contained in our product are used by the customer in a manner that does not comply any more with the purpose of the contract, which is the basis of the acquisition of our product. This concerns in particular any use of the open-source software programs outside of our product. The warranty and liability regulations that are provided by the respective effective open-source software license for the respective open-source software as listed in the following are effective for the use of the open-source software beyond the purpose of the contract. In particular, we are not liable, if the open-source software in our product or the complete software configuration in our product is changed. The warranty granted with the contract, which is the basis of the acquisition of our product, is only effective for the unchanged open-source software and the unchanged software configuration in our product.

## 3.3 Used Open-Source Software

Please contact our support department ([support@insys-icom.de](mailto:support@insys-icom.de)) for a list of the open-source software used in this product. Alternatively, you'll find a list of the open-source software in the web interface of the routers under Help -> Licences.



## 4 Version History

Version	Modification
1.0	Release

## 5 Device Variants

This manual describes different variants of the industrial router series ECR of INSYS icom. The routers are referred to as ECR in this manual. The routers are:

- ECR-EW300 (LAN-WLAN router)
- ECR-LW300 (LTE-WLAN router)
- ECR-LW320 (LTE-WLAN router for Australia)

If the routers are different, this will be mentioned explicitly in the respective sections.

## 6 Scope of Delivery

The scope of delivery includes all accessories listed below. Please check if all accessories are included in the box. If a part is missing or damaged, please contact your distributor.

- Industrial Routers
- Quick Installation Guide
- Safety Instructions
- DIN rail adapter

The scope of delivery does not include optional accessories. Among other things, the following parts are available from your distributor or INSYS icom:

- Cellular antennas
- Antenna extensions and accessories
- Din rail power supply units
- Device App icom Data Suite
- VPN service icom Connectivity Suite - VPN
- M2M SIM card and management portal  
icom Connectivity Suite - M2M SIM

## **7 Technical Information**

The following information applies to all variants of the router. If these variants differ, the different values will be indicated separately.

### **7.1 Technical Data**

#### **7.1.1 Physical Features**

All specified data was measured with nominal input voltage, at full load, and an ambient temperature of 25 °C. The limit value tolerances are subject to the usual variations.

Physical Feature	Value
Operating voltage	12 V ... 24 V DC ( $\pm 20\%$ )
Max. power of power supply	<4 kW
Power consumption ECR-EW ECR-LW Sleep mode	Typ. approx. 2.5 W, max. 4 W Typ. approx. 3 W, max. 7 W Typ. approx. 55 mW
Level input	HIGH level = 10 ... 24 V LOW level = 0 ... 5 V Contact open condition: LOW
Current consumption input at HIGH potential	Max. 3 mA at 24 V DC
Digital output (open collector), max. load	24 V (DC), 100 mA
Max. voltage drop of the output in condition ON	< 1 V (DC) at 100 mA load
Output power cellular engine EGSM 900 Class 4 GSM 1800 Class 1 GSM 900 8-PSK Class E2 GSM 1800 8-PSK Class E2 UMTS 900/2100 Class 3 LTE 700/800/900/1800/2100 Class 3	+33 dBm $\pm 2$ dB +30 dBm $\pm 2$ dB +27 dBm $\pm 3$ dB +26 dBm $+3/-4$ dB +23.5 dBm $+1.5/-2.5$ dB +23 dBm $+1/-2$ dB
Output power WLAN	Max. 100 mW
Weight	Max. 280 g
Dimensions - Width - Height - Depth Horizontal pitch on DIN rail	105 mm 95 mm (118 mm with lugs) 42 mm 2,5 / 6 units (depending on mounting direction)
Temperature range	-30 °C ... 70 °C (extended 75 °C) see ⓘ below
Maximum permissible humidity	95% non-condensing
IP rating	Housing IP40

Table 1: ECR – physical features

- ⓘ The extended temperature range allows a temporary operation under increased temperatures. Functional limitations (in particular for data transmission) may occur with this. This serves to protect the internal electronics. The device itself will not be damaged in any case.

### 7.1.2 Technological Features

Technological Feature	Description
Ethernet port	10/100 Mbit/s full/half duplex auto sense; automatic detection of "crossover" or "patch" wiring.
RS232 interface	Max. baud rate 230,400 bit/s; hardware handshake RTS/CTS; software handshake XON/XOFF; various data formats
RS485 interface	Max. baud rate 230,400 bit/s
Sleep mode	Energy conservation mode with wake-up by event, timer, reset or re-applying the power supply
GSM/GPRS frequency bands (2G)	900, 1800 MHz (ECR-LW300)
UMTS/HSPA frequency bands (3G)	900, 2100 MHz, bands 1, 8 (ECR-LW300) 850, 900, 2100 MHz, bands 1, 5, 8 (ECR-LW320)
LTE frequency bands (4G)	700, 800, 900, 1800, 2100 MHz, bands 1, 3, 8, 20, 28 (ECR-LW300) 700, 850, 900, 1800 MHz, bands 3, 5, 8, 28 (ECR-LW320)
SIM card reader	Support for 1.8 V and 3.0 V SIM cards Format: Mini-SIM (2FF), locked, dual SIM (alternative redundancy, no parallel operation)
SMS	Dispatch / receipt
GPRS	GPRS Multislot Class 12, Coding scheme 1 to 4, PBCCH, Mobile Station Class B
EDGE (EGPRS)	Uplink up to 85.6 kbit/s / downlink up to 85.6 kbit/s EDGE Multislot Class 12, Modulation and Coding Scheme MCS 1-9
UMTS/HSPA	Uplink up to 5.2 MBit/s / downlink up to 7.2 MBit/s UE CAT. 1
LTE	Uplink up to 5.2 MBit/s / downlink up to 10.2 MBit/s UE CAT. 1
WLAN	IEEE 802.11 b/g/n, 2,4 GH WLAN station (client), WLAN-AP for up to 10 clients simultaneously, WPA/WPA2 (AES, TKIP), 802.1x (EAP. TLS, TTLS, PEAP)

Table 2: ECR – technological features

**i** The available data rates depend on reception conditions and support of the respective provider (contract extent and network utilisation).

## 7.2 Connections, display and control elements

The following figures show a maximum equipped variant of the router. Depending on the variant, your router might not provide all connections, display or control elements.

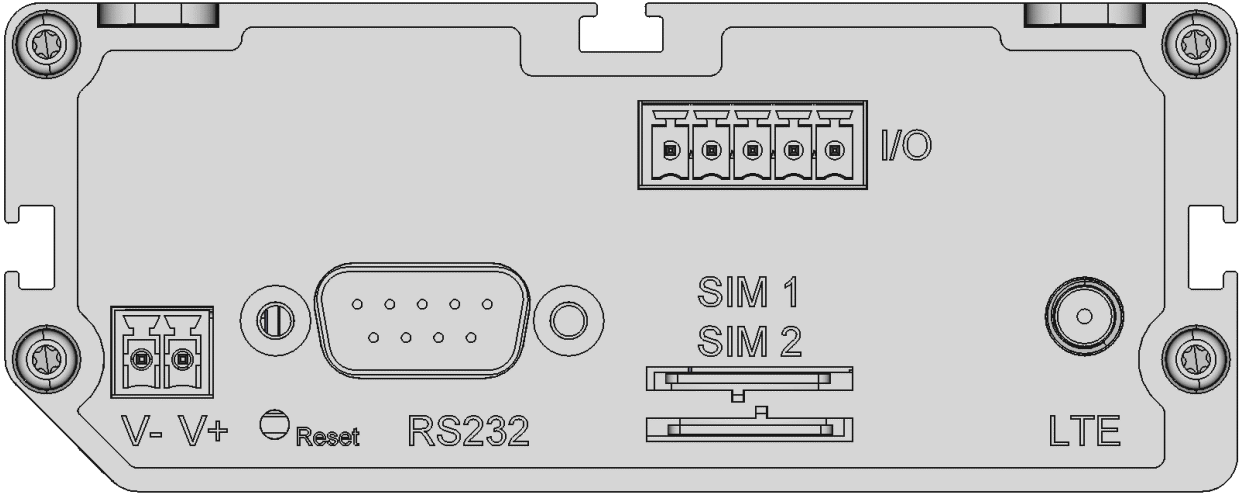

Figure 1: ECR – connections, display and control elements at the top

Connection	Description
V- V+	Power supply
Reset	Reset key
RS232	Serial RS232 interface (D-Sub connector, V.28)
SIM 1/2	SIM card reader (only ECR-LW)
LTE	Cellular antenna (SMA socket, only ECR-LW)
I/O	I/O interface

Table 3: ECR – connections, display and control elements at the top

- ⓘ The screen of the antenna system must be connected to the protective conductor when using an outside mounted antenna.

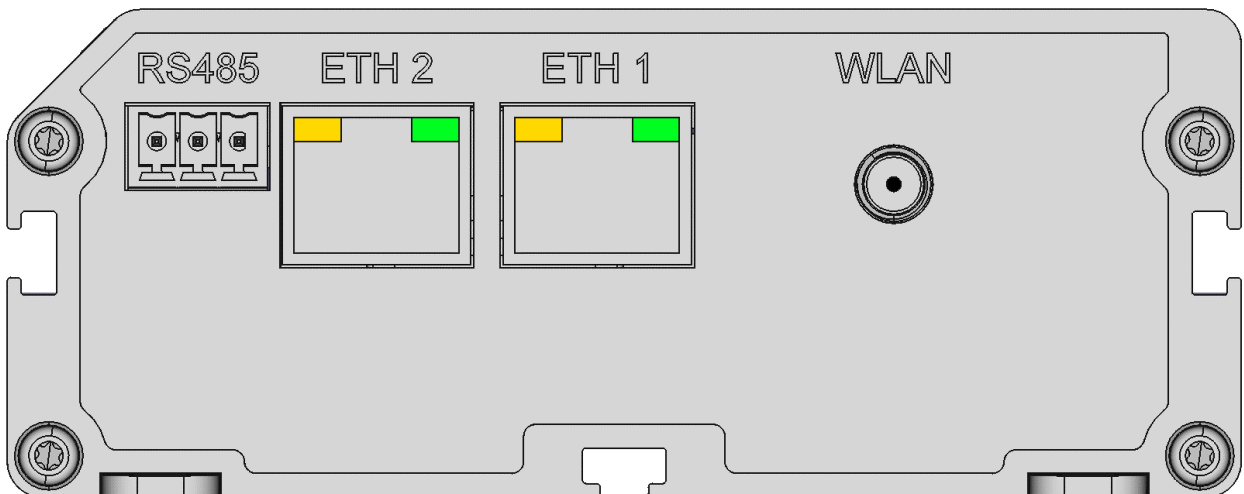

Figure 2: ECR – connections, display and control elements at the bottom

Connection	Description
RS485	Serial RS485 interface (connector provided)
ETH 1	Ethernet port 1 (RJ45, 10/100 BT)
ETH 2	Ethernet port 2 (RJ45, 10/100 BT)
WLAN	WLAN antenna (RP-SMA socket (reverse polarity))

Table 4: ECR – connections, display and control elements at the bottom

- ⓘ WLAN antennas with an antenna gain of more than 4 dBi must not be used!



Figure 3: ECR – connections, display and control elements at the front



LED	Colour	Function	off	blinking	on
Power	green	Supply	not available	1x for soft reset 3x for resetting to default settings	present
WAN	green	WAN chain	inactive	establishing	established
Signal	green	Signal (only ECR-LW)	no signal or logged out	logged in (field strength see Table 6)	
ETH 1-2	green	Link / Activity	not connected	Data traffic	connected
	yellow	Data rate	10 Mbit/s		100 Mbit/s

Table 5: ECR – meaning of the display elements

Blinking interval LED signal (only ECR-LW)	Signal quality
900 ms on, 100 ms off	very good
200 ms on, 200 ms off	good
100 ms on, 900 ms off	poor
off	no signal or logged out

Table 6: Blinking code of the signal LED

Designation	Operation	Meaning
Reset	Press once for a short time.	Resets the software and restarts it. (Soft reset)
	Press at least 3 seconds.	Resets the hardware and restarts it. (Hard reset)
	Press three times for a short time within 2 seconds.	Deletes all settings and resets the device to the factory defaults.

Table 7: ECR – description of the functions and meaning of the control elements

### 7.3 Power supply

The connection to an AC supply network must be made using a suitable power supply unit.

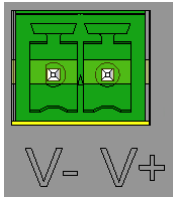

Figure 4: ECR – power supply connection

Connection	Description
V-	Power supply, negative terminal
V+	Power supply, positive terminal

Table 8: ECR – power supply connections

### 7.4 Inputs and Outputs

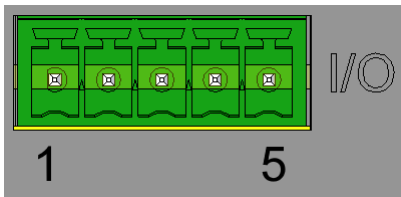

Figure 5: ECR – I/O interface connection

Connection	Signal	Description
1	IN1	Digital input 1
2	IN2	Digital input 2
3	GND	Ground
4	OUT1	Digital output 1
5	OUT2	Digital output 2

Table 9: ECR – I/O interface connections

#### 7.4.1 Digital inputs

The router has two digital inputs. The inputs are high-active and based on the electrical requirements of the PLC standard DIN EN 61131-2 for digital inputs type 1. You'll find more information in Table 1.

#### 7.4.2 Digital outputs

The router has two digital outputs that are designed as open collector outputs. You'll find more information in Table 1.

## 7.5 RS232 interface



Figure 6: ECR – RS232 interface connection

Connector	Signal	Description
1	DCD	Data Carrier Detect
2	RXD	Receive Data
3	TXD	Transmit Data
4	DTR	Data Terminal Ready
5	GND	Ground
6	DSR	Data Set Ready
7	RTS	Request To Send
8	CTS	Clear To Send
9	RI	Ring Indication

Table 10: ECR – RS232 interface connections

- ⓘ The RS232 interface conforms to the layout as DTE (Data Terminal Equipment)

## 7.6 RS485 interface

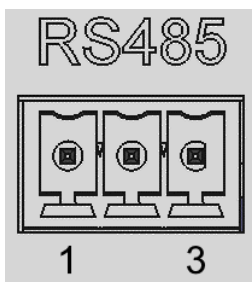

Figure 7: ECR – RS485 interface connection

Connector	Signal	Description
1	COM	Common (frame GND)
2	D+	Data line positive
3	D-	Data line negative

Table 11: Description of the pin allocation of the RS485 interface

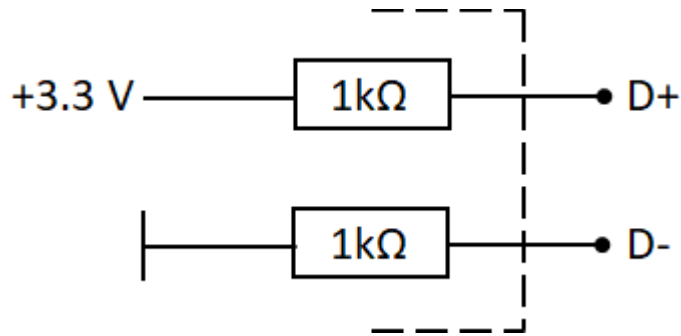

Figure 8: Principle circuit diagram of the RS485 interface

### 7.7 Connecting the connectors

The wires are contacted in the connector via screw terminals. The tightening torque is 0.5 – 0.6 Nm.

The permissible wire cross-sections can be found in the following table.

Wire	Cross-section
Nominal cross-section	1.5 mm <sup>2</sup>
Rigid	0.2 – 1.5 mm <sup>2</sup>
Flexible	0.2 – 1.5 mm <sup>2</sup>
Flexible with end sleeve	0.25 – 1.5 mm <sup>2</sup>

Table 12: Permissible wire cross-sections for connectors

### 7.8 Maximum line lengths

The maximum line lengths to the connections can be found in the following table.

Wire	Max. length
Antennas, power supply, serial interfaces, inputs and outputs, other signals	30 m

Table 13: Permissible line lengths

## 8 Assembly

The router can be mounted in two different ways:

- Screw mounting using the four mounting lugs
- DIN rail mounting using the optional DIN rail adapter

This section describes how you can install the router, connect the power supply and demount it again. Observe the instructions in the "Safety" section of this manual, in particular the "Safety Instructions for Electrical Installation" for that purpose unconditionally.

### Caution!



**Moisture and liquids from the environment may seep into the interior of the device!**

**Fire hazard and damage of the product.**

The device must not be used in wet or damp environments, or in the direct vicinity of water. Install the device at a dry location, protected from water spray. Disconnect the power supply before you perform any work on a device which may have been in contact with moisture.

### Caution!



**The device could be destroyed if the wrong power supply is used!**

**If the device is operated with a power supply that supplies a voltage exceeding the permissible operating voltage, it will be destroyed.**

Make sure that you use the suitable power supply. Refer to the Technical Data section for the proper voltage range.

## 8.1 Screw mounting

The four mounting lugs provided at the housing allow mounting on even and stable underground. The mounting material is not included and must be selected according to the underground.

### Mounting the device using screws

How to mount the router to an even underground:

- The underground is level (make even if required) and sufficiently stable.
- You have four suitable screws (max. diameter 4 mm), four suiting washers and, if required, four suiting dowels.

❗ If the underground is not level, it might be compensated if required (e.g. by shimming with washers) to avoid that a mounting lug breaks off if it is folded too much during fastening.

1. **Remove a possibly pre-installed DIN rail adapter.**
2. **Mark the four bore holes using the device or the specified dimensions on the underground.**

❗ Do not forget to provide sufficient space under and above the router for connecting the necessary cables. The cables must not be bended excessively. The space may be reduced when using angular connectors.

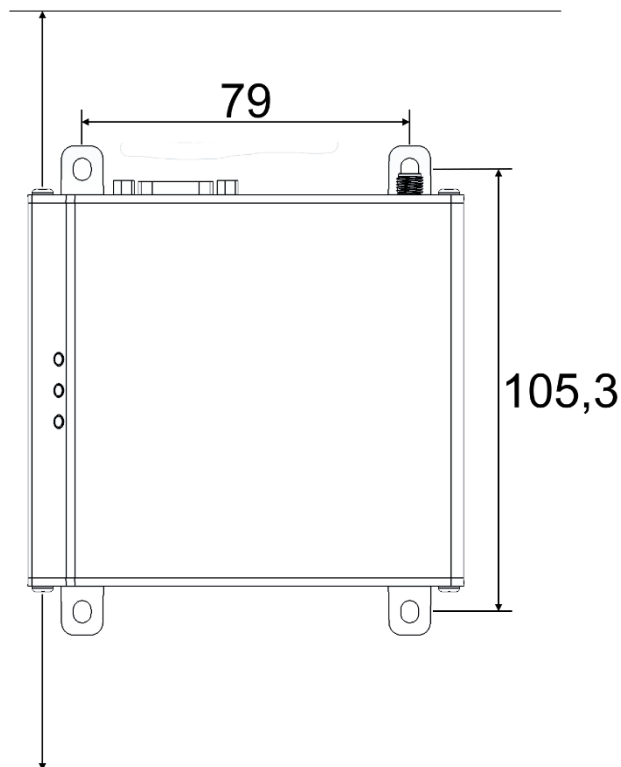

3. **Drill the four mounting bores using a suitable drill bit in the required diameter into the underground.**

4. ***Screw the router against the underground at all four mounting lugs with a washer under the screw head.***

✓ The router is now readily mounted.

## 8.2 DIN rail mounting

A DIN rail adapter is provided for DIN rail mounting. Depending on the space available in the switch cabinet, the adapter may be inserted into the groove at the back or at the side (more space in width or depth). To do this, the fastening screws must be untightened slightly, the adapter must be slid in the other groove and the fastening screws must be tightened again (take care to re-install the adapter with the spring facing up).

The four mounting lugs may be broken off without any tools at the rated breaking point, if required.

### Mounting the device to the DIN rail

How to mount the router to a DIN rail:

1. ***Place the device at the DIN rail Hook the upper DIN rail groove into place behind the upper edge of the DIN rail.***
2. ***Fold down the device perpendicular to the DIN rail until the lower DIN rail groove latches in the DIN rail.***

✓ The router is now readily mounted.

### Removing the device from the DIN rail

How to uninstall the router from a DIN rail in a switch cabinet:

- The power supply of the switch cabinet is switched off and secured against being switched on accidentally.
  - All connectors at the device are disconnected.
1. ***Push the device slightly down to compress the retaining spring and swing it away from the DIN rail.***
  2. ***Un-hook the device and take it off perpendicularly to the DIN rail.***

✓ The router is now removed.

## 8.3 Connecting the power supply

### Connecting the power supply

- The device has already been mounted to the DIN rail.
- The power supply is connected and switched off.

- 1. *Disconnect the push-in terminal connector.***
- 2. *Connect the ground lead of the power supply to the terminal "V-" of the terminal connector.***
- 3. *Connect the positive lead of the power supply to the terminal "V+" of the terminal connector.***
- 4. *Connect the push-in terminal connector again.***

- ✓ The router is now connected to the power supply.

### Disconnecting the power supply

- The device is mounted to the DIN rail.
- The power supply is connected and switched off.

- 1. *Disconnect the push-in terminal connector.***

- ✓ The router is disconnected from the power supply.



## 9 Commissioning

This chapter describes how to commission the router, i.e. how to connect it to a PC and how to prepare it for the configuration.

### Insert SIM card (only cellular version).

How to insert the SIM card.

- The power supply is disabled.
- You will need a functionable Mini-SIM card of your mobile provider.
- You will also need the associated PIN.

#### 1. ***Insert your SIM card into the SIM card slot.***

- ① The SIM card will only fit into the SIM card slot in one position. Make sure that the SIM card contacts are facing down and the card is inserted into the SIM card slot with the chamfer facing forward.
- ① In case of devices with two SIM card slots, the first SIM card must be inserted into slot "SIM 1". Optionally, a second SIM card can be inserted into the slot "SIM 2" (redundant operation).

#### 2. ***Press the SIM card gently into the SIM card slot using a finger until it snaps in.***

- ① In order to remove the SIM card, briefly press on the card. The card will then be ejected a little bit and can be removed.

#### 3. ***Enable the power supply again.***

### Connecting a cellular antenna (only cellular version)

How to connect the router to a cellular antenna.

- The power supply is disabled.
- You will need a suitable cellular antenna (available from INSYS icom).
- ① When selecting and mounting the antenna, make sure to comply with CE conformity.

#### 1. ***Connect the cellular antenna to the antenna connection.***

- ✓ The cellular antenna is connected with this.

## Connecting a PC

How to connect the router to a PC via a network cable.

- The power supply is disabled.
- You will need a Cat 5 network patch cable
- You will need a network card in the PC.

- 1. Locate the RJ-45 socket of the network card at the PC.**
- 2. Plug one end of the network cable into the RJ45 socket of the PC, and the other end into the ETH 1 socket of the router.**

✓ The router is connected to the PC with this.

## How to configure the router

- The device is connected to the PC.
- The power supply of the device is enabled and the device is ready for operation (Power LED is illuminated green).
- You have the required access rights to change the IP address of the network card to which the router is connected.

- 1. Make sure that the DHCP client is enabled for the PC (Obtain an IP address automatically).**

ⓘ The integrated DHCP server of the router will then allocate an address from the according address range to your network card.

- *Alternatively, you can change the IP address of the network card to which the device is connected to an address that starts with 192.168.1. Do not use the address 192.168.1.1 here. This is the factory default IP address of the device. For example, use 192.168.1.2 as IP address for the network card in your PC.*

- 2. Open a web browser and enter the URL "http://192.168.1.1" into the address bar.**

✓ The browser loads the start page of the router.

- *If you see the message in your browser window that the page with this address cannot be found, follow the following steps: Check, whether the device is supplied with power. If yes, most probably a wrong IP address is configured in the device. Press the reset key three times within two seconds and repeat this instruction from step 2.*

✓ A dialogue will prompt you to enter a user name and password for authentication.

**3. Enter the user name "insys" and the password "icom".**

- ① User name and password are set as factory defaults. If the registration at the web interface does not work with the data entered, just reset the device to the factory defaults.  
Press the reset key three times within two seconds and repeat this instruction from step 2.
- ✓ You should now see the start page of the web interface.
- ✓ The router is installed successfully and ready for configuration.
- ① Due to reasons of security, the session will be terminated after 15 minutes of inactivity (default setting) and you need to login again.

# 10 Operating Principle

This chapter describes how to operate and configure the router.

There are different options for configuration and operation:

- Via a web-based interface (web interface). The web interface itself is displayed and operated using a web browser. Operation via web interface and access via HTTPS protocol are described in the following.
- Via a command line interface (CLI) Configuration and operation via command line are described in detail in the online help of the router.
- Via a configuration file (binary or ASCII). Configuration and operation via a configuration file are described in detail in the online help of the router.

Profiles are used for all types of configuration. The basic handling of these profiles are described at the end of this section.

## 10.1 Operation via the web interface

The web interface allows easy configuration using a web browser. All functions can be configured via the web interface. The operation is mostly self-explanatory. The web interface also provides an inline help feature, which describes the meaning of possible settings. The inline help is displayed by selecting the button  "Display help text" in the title bar besides the language selection. An online help is available for more detailed explanation. It can be opened using links in the inline help.

- ① We urgently recommend to enable inline help for the first configurations to allow a quick and flawless configuration. If the inline help is enabled during configuration, all unsaved changes on this page will be lost.

### Access to the Web Interface

How to access the web interface basically.

- The device is ready for operation and you have access to it (refer to Commissioning section).

#### 1. **Start the web browser and enter the IP address into the address bar.**

- ① The factory default IP address is **192.168.1.1**.
- ✓ A login screen will prompt you to enter the user name and the password for authentication.
- ① Due to reasons of security, the session will be terminated after 15 minutes of inactivity and you need to login again.

#### 2. **Enter the user name and the password and click OK.**

- ① The default settings of the web interface are as follows:  
the **user name** is "insys", the **password** is "icom".
- ✓ The start page of the web interface is displayed.
- 3. Use the menu on the left side to select the menu item, in which you want to change settings.**
- 4. Enter the required settings.**
- 5. Click on the button OK on the according configuration page to save the settings in the profile.**
  - ① Consider the information in the profile section about the effectivity of configurations made.

### Language selection in the web interface

How to change the language in the web interface.

→ The device is ready for operation and you have access to the web interface.

- 1. Select in the title bar the button  for German or  for English.**

✓ The web interface is displayed in the selected language then.

### Logging out from the web interface

How to log off from the web interface. This prevents unauthorised access after completing the configuration.

→ The device is ready for operation and you have access to the web interface.

- 1. Select in the title bar the button  (Logout).**

✓ You will be logged out from the web interface and returned to the login screen.

① A session will also be terminated after 15 minutes of inactivity (default setting) due to security reasons.

## 10.2 Access via HTTPS Protocol

The web interface also allows a secure configuration using the HTTPS protocol. The HTTPS protocol allows an authentication of the server (i.e. the router) as well as an encryption of the data transmission.

### 10.2.1 Authentication via the device-individual certificate/key combination

The router will be authenticated via self-certified device-individual certificate/key combination by default. In case of a first access via the HTTPS protocol, the browser indicates that the router uses an invalid security certificate. The certificate is not trusted, because the CA (certification authority) certificate is unknown. You can ignore this warning and (depending on browser and operating system) add an exception for this server or establish the secure connection to this server nevertheless.

We recommend to download the CA certificate `CA_INSYS_Router.pem` from the firmware page (<http://www.insys-icom.com/firmware/>) and import it into your browser, to approve INSYS MICROELECTRONICS as certification authority. Proceed for this as described in the documentation of your browser.

If INSYS MICROELECTRONICS is stored as certification authority in your browser and you access the device again via the HTTPS protocol, the browser indicates again that an invalid security certificate is used. The certificate is not trusted, because the Common Name of the certificate differs from your input in the address bar of the browser. The browser indicates that a different device answers under this URL. The Common Name of the certificate consists of the MAC address of the router, where the colons are replaced by underscores. You can ignore this warning and (depending on browser and operating system) add an exception for this server or establish the secure connection to this server nevertheless.

In order to avoid this browser warning as well, you must enter the Common Name of the router to be accessed into the address bar of your browser. The Common Name must be connected with the IP address of the device that the URL leads to the correct device. You can find out the general name (Common Name) by downloading and viewing the certificate from the device. The proceeding for this depends on your browser. The proceeding for setting up the link depends on your operating system.

- Editing of `/etc/hosts` (Linux/Unix)
- Editing of `C:\WINDOWS\system32\drivers\etc\hosts` (Windows XP/7/8/10)
- Configuring your own DNS server

For further information, refer to the documentation of your operating system.

## 10.2.2 Authentication via an own certificate structure

Alternatively, it is also possible to use an own certificate structure and upload a self-generated certificate/key combination to the router to use this for the access via an HTTPS connection.

You need to upload your self-generated certificate/key combination in the certificate manager of the router first (menu Administration -> Certificates).

Then, this certificate/key combination must be selected when configuring the web interface access via HTTPS (menu Administration -> Web interface).

## 10.3 Profiles and Profile Handling

The configuration of the router is called profile. Several profiles can be stored on one device so that the configuration of a device can be changed quickly.

### 10.3.1 Term definitions

The following terms are to be distinguished:

- Running profile: the current configuration of the router which is used for operation at the moment
- Stored profile: one of several possible profiles that are stored on the router by the user
- Opened profile: the profile that is currently displayed in the web interface (or CLI) for editing

Simple applications do not require the use of more than one profile. However, the router allows many applications by using several profiles. From risk-free testing of modified configurations up to time- or event-triggered switching of different profiles, there are almost no limits for your application.

If the running profile differs from the opened profile, this will be indicated by the appearance of a blinking gear symbol  with the button "Activate profile".

Following an intentional or unintentional restart of the router (e.g. power supply interruption), the previously running profile will continue to run and the last activated profile will be opened again. If they differ, the button with the gear symbol  blinks again.

### 10.3.2 Working with one profile

If only one profile is used, the current (opened) profile can be configured in the web interface. Settings made in the opened profile are stored in this profile with a click on the button "OK". They will not become effective in the running profile with this.



If the current profile has been modified, the blinking gear symbol  appears in the title bar. A click on the button with the blinking gear symbol  activates the opened profile, i.e. it becomes the running profile and the modifications of the router configuration become effective. The gear symbol will disappear.



Figure 9: Profile handling – activating configuration modifications



### 10.3.3 Using several profiles

The versatile possible applications of the router suggest the use of several profiles. The following sections describe the profile handling.

#### 10.3.3.1 Storing a profile

Settings made in the opened profile are stored in this profile with a click on the button "OK". They will not become effective in the running profile with this. They become only effective if the opened profile is activated, i.e. made the running profile.

#### 10.3.3.2 Activating a profile

A click on the button with the blinking gear symbol  in the title bar activates the opened profile, i.e. it becomes the running profile.

A stored profile can be activated and opened in the "Administration" menu on the "Profiles" page by clicking the button with the gear symbol  behind the respective profile.

#### 10.3.3.3 Opening a profile for editing

A stored profile can be opened in the "Administration" menu on the "Profiles" page by clicking the button with the folder symbol  behind the respective profile.

#### 10.3.3.4 Creating a profile

A new profile can be created from:

- the running profile
- stored profiles
- the default settings

For this, you need to make the correspondent selection in the "Administration" menu on the "Profiles" page behind "Create profile from". The new profile will be created with a click on the button "OK" and it appears in the list of profiles.

The profile can then be given a descriptive name. It must first be opened to edit it.

#### 10.3.3.5 Exporting a profile

Profiles stored on the router can be exported to the computer, i.e. downloaded in the "Administration" menu on the "Profiles" page.

A click on the button for the binary file download  behind the respective profile downloads the profile as a binary file. This is recommended to archive the profile or transmit it to another router, e.g. a backup device.

A click on the button for the ASCII file download  behind the respective profile downloads the profile as an ASCII configuration file. This is recommended if the profile is to be edited manually on the computer.

### 10.3.3.6 Importing a profile

Profiles (in binary format) or ASCII configuration files can be uploaded to the router in the "Administration" menu on the "Profiles" page.

You need to locate the respective file on the computer under "Import profile or ASCII configuration file" for this. The profile will be uploaded with a click on the button "OK" and it appears in the respective list.

### 10.3.3.7 Deleting a profile

A stored profile can be deleted in the "Administration" menu on the "Profiles" page by clicking the button with the recycle bin symbol  behind the respective profile.

### 10.3.3.8 Comparing two profiles

To show the differences between two profiles, it is possible to compare the default settings, the running profile and the stored profiles to each other.

For this, you need to select the two profiles to be compared in the "Administration" menu on the "Profiles" page under "Compare profiles". The different settings of both profiles are displayed side by side when clicking the button "OK".

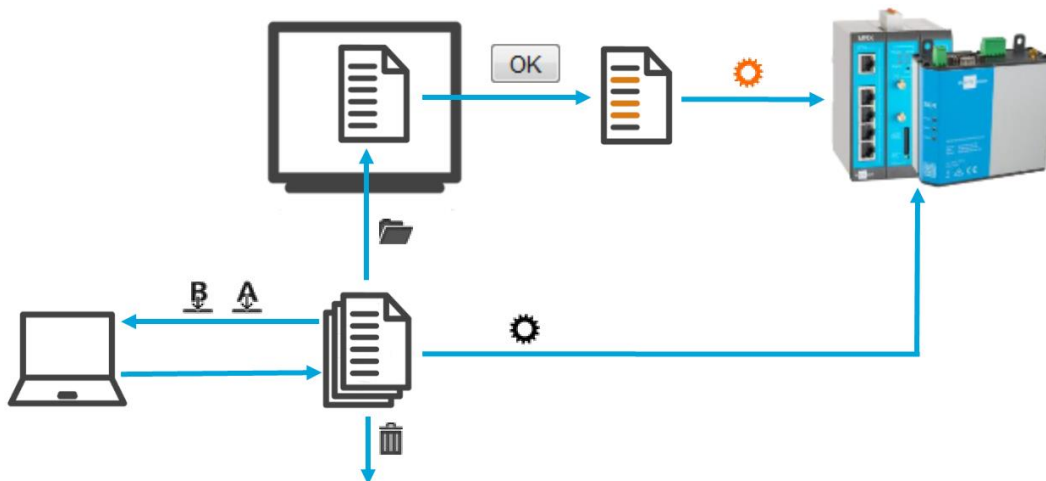

Figure 10: Profile handling – scheme

## 10.3.4 ASCII Configuration

ASCII configurations are a sequence of commands as they could also be entered in the CLI. Each line contains a command that modifies the opened profile.

Syntax and parameters can be taken from a downloaded profile in ASCII format for example. Refer to the CLI description for further information about the syntax.

Commands that affect plug-in cards that are not installed will be taken over to the profile, but will have no effect.

# 11 Maintenance, Repair and Troubleshooting

## 11.1 Maintenance

The product is maintenance-free and does not require special regular maintenance.

## 11.2 Troubleshooting

If a failure occurs during the operation of the product, you will find troubleshooting tips in the "Knowledge Base" on our web site (<http://www.insys-icom.de/knowledge/>). If you need further support, please contact your reseller or INSYS icom. You can contact our support team via e-mail under [support@insys-tec.de](mailto:support@insys-tec.de).

## 11.3 Repair

Send defect devices with detailed failure description to the source of supply of your device. If you have purchased the device directly from INSYS icom, send the device to: INSYS MICROELECTRONICS GmbH, Hermann-Köhl-Str. 22, 93049 Regensburg.

Before dispatching the device:

- Remove any inserted SIM cards.
- Backup the configuration on the device and any other stored data if required.
- Backup any sandbox applications running on the device.

### Caution!



Short circuits and damage due to improper repairs and modifications of products.

Fire hazard and damage of the product.

It is not permitted to open the product for repair or modification.

## 12 Waste Disposal

### 12.1 Repurchasing of Legacy Systems

According to the new WEEE guidelines, the repurchasing and recycling of legacy systems for our clients is regulated as follows:

Please send those legacy systems to the following address, carriage prepaid:

Frankenberg-Metalle  
Gaertnersleite 8  
D-96450 Coburg  
Germany

This regulation applies to all devices which were delivered after August 13, 2005.

- ① Please consider possible stored passwords or security certificates before disposing the device. It is recommended to block possible existing access rights for the device (e.g. on your VPN server) and reset the device to default settings (if possible), before passing it on or disposing it.

## 13 Declaration of Conformity

Hereby, INSYS Microelectronics GmbH declares that the device type ECR is in compliance with Directives 2014/53/EU and 2011/65/EU. The full text of the EC Declaration of Conformity is available under the following Internet address:  
[www.insys-icom.com/manual](http://www.insys-icom.com/manual)

For compliance with CE conformity, it is also necessary to comply with DIN EN62311. This controls the exposure of persons to electromagnetic fields.

Adherence to the following boundary condition is necessary for this:

- Persons do not come closer to the antenna than 20 cm for a prolonged time in normal use.
- Only use antennas that we have been approved for the use with this product in our evaluation procedure.

## 14 Export Restriction

The chip sets for analogue modems and cellular radio adapters used by INSYS Microelectronics GmbH are subject to export restrictions as per US ECCN classification (5A991).

**Therefore, it is not allowed to export these communication devices into the following countries (at the time when this publication has been issued): Cuba, Iran, North Korea, Sudan, Syria**

The currently effective country list can be found in section „Country Group E“ in the document "Supplement No. 1 to Part 740" of the Export Administration Regulations (EAR) (<http://www.bis.doc.gov>). Please contact the US authorities directly for a special permit.

We want to make you aware that the US legislation may have an effect in Germany. Amongst others, it may happen that US companies may be precluded from supplying foreign violators of the EAR on the basis of US legislation.

### Note



#### Export restriction!

#### Possible violation of export regulations.

This device uses encryption technology and is therefore subject to export control as per German (AL classification 5A002) and European law (EG-DUAL-USE VO 428/2009). The export from Germany requires a permission of the Bundesamt für Wirtschaft und Ausfuhrkontrolle (Federal Office of Economics and Export Control).

This device may contain components with US origin. Possible export conditions as per US law (ECCN classification) will be mentioned explicitly on receipts, if possible, or can always be requested.

## 15 Glossary

This describes the most important terms and abbreviations of this manual.

- APN:** Access Point Name, computer name that provides cellular subscribers of the GPRS network with Internet access.
- AT command:** Commands to devices such as modems to set up this device.
- Broadcast:** Data packet that is sent to all participants of a network.
- Caller ID:** Phone number transmitted by the caller that can be evaluated by the called device.
- Client:** Device that requests services from another device (server).
- CLIP:** Calling Line Identification Presentation is a service feature for incoming calls in analogue and ISDN telephone networks as well as cellular radio. The caller ID of the caller is transmitted to the recipient.
- CHAP:** Challenge Handshake Authentication Protocol; an authentication protocol often used for PPP connections.
- DHCP:** Dynamic Host Configuration Protocol; DHCP servers can dynamically design an IP address and other parameters to DHCP clients on request.
- DFÜ:** Datenfernübertragung (remote data transmission); data can be exchanged between computers over considerable distances. The transmission is often realised with modems and the PPP protocol.
- DNS:** Domain Name System; service used for the translation of domain names into IP addresses.
- Domain name:** The domain is the name of an Internet site (e.g. insys-icom). It consists of the name and an extension (Top Level Domain, e.g. .com), (e.g. insys-icom.com).
- EDGE:** Enhanced Data Rates for GSM Evolution designates a technology for increasing the data rate in GSM cellular networks by introducing an additional modulation process. EDGE enhances GPRS to E-GPRS (Enhanced GPRS) and HSCSD to ECSD.
- Firewall:** Network rules that block in particular data packets to certain sources or destinations.
- Gateway:** This is a machine that works like a router. In contrast to the router, a gateway can also route data packets from different hardware networks.
- GPRS:** General Packet Radio Service; advancement of the -> GSM cellular network to achieve higher data transmission rates.

- GSM:** Global System for Mobile communications; cellular network for voice and data transmission.
- ICMP:** Internet Control Message Protocol; protocol that is often used to control a network. The program "ping" uses ICMP for example.
- Interface:** A network device that can transport IP connections.
- IP address:** Internet Protocol address; The IP address of a device in a network under which it can be accessed. It consists of four bytes and is indicated decimal, (e.g. 192.168.1.1)
- IP network:** An Ethernet-based interface that can become a LAN or a WAN interface.
- ISP:** Internet Service Provider; an ISP can be called using a dial-up connection (e.g. with an analogue modem or ISDN-TA). The ISP will then provide access to the Internet via this dial-up connection.
- LAN:** Local Area Network; a network of computers which are located relatively close to each other.
- LAN interface:** An interface that is assigned to a local network (plant network, machine network, local network); it is connected to a WAN via the router.
- MAC address:** Media Access Control Address. A MAC is a part of an Ethernet interface. Each Ethernet interface has a unique global number, the MAC address.
- MSN:** Multiple Subscriber Number. Devices that are active on an So bus require an answerback code in form of a terminal device number.
- Netzmask:** Defines a logical group of IP addresses in net address and device addresses.
- Net address:** Consists of the overlap of IP address and netmask. It always ends with "0". The netmask (e.g. 255.255.255.0) is applied in binary form to an IP address (e.g. 192.168.1.1); the still "visible" part of this overlapping (masking) is the net address (here: 192.168.1.0).
- Network rules:** You decide how the different data packets are handled in a network device. You can block or redirect data packets to or from certain network participants for example.
- PAP:** Password Authentication Protocol; an authentication protocol often used for PPP connections.
- Port:** (1) Socket at the switch for connecting Ethernet devices.  
(2) Part of a socket for data connections
- Port forwarding:** Network rules that redirect data packets from certain senders to special recipients of a network.



- PPP:** Point to Point Protocol; a protocol, which connects two machines via a serial line to enable the exchange of TCP/IP packets between those two machines.
- PPPoE:** Point to Point Protocol over Ethernet; a protocol, which connects two devices via an Ethernet line to enable the exchange of TCP/IP packets between those two machines.
- Router:** This is a machine in a network, which is responsible for the incoming data of a protocol to be forwarded to the planned destination or sub network.
- SCN:** Service Center Number, phone number of the computer that accepts short messages (->SMS) via the GSM network and forwards them to the recipients.
- Server:** Device that provides services, e.g. web server, to other devices (client).
- SMS:** Short Message Service; short messages can be sent via the GSM cellular network.
- Socket:** Data connections that are established using ->TCP or ->UDP use sockets for addressing. A socket consists of an IP address and a port (cf. address: street name and number)
- Switch:** A device that can connect several machines with the Ethernet. In contrast to a hub, a switch will "think" by itself, i.e. it can remember the MAC addresses connected to a port and directs the traffic more efficiently to the individual ports.
- TCP:** Transmission Control Protocol; a transport protocol to enable data exchange between network devices. It operates "connection-based", i.t. the data transmission is protected.
- UDP:** User Datagram Protocol; a transport protocol to enable data exchange between network devices. It operates "without connection", i.t. the data transmission is not protected.
- UMTS:** Universal Mobile Telecommunications System stands for the third generation cellular standard (3G) that allows significantly higher data transmission rates (384 kbit/s to 7,2 Mbit/s) than the second generation cellular standard (2G), the GSM standard (9,6 kbit/s to 220 kbit/s).
- URL:** Uniform Resource Locator; this is the address used by a service to be found in the web browser. In this manual, an URL is mostly entered as the IP address of the device.

- VPN:** Virtual Private Network; logical connections (so-called tunnels) are established via existing unsafe connections. The end points of these connections (tunnel ends) and the devices behind can be considered as an independent logical network. A very high degree of tap- and tamper-resistance can be achieved with the encryption of the data transmission via the tunnels and the previous two-way authentication of the participants at this logical network.
- WAN:** Wide Area Network; a network consisting of computers, which are located far away from each other.
- WAN group:** Defines a collection of WAN interfaces that can be started or stopped in parallel.
- WAN interface:** An interface that serves to connect the local network (or one of the local networks) with a superordinate network.
- WAN chain:** Defines a WAN by arranging WAN interfaces or WAN groups in a sequence.

## 16 Tables and Diagrams

### 16.1 List of Tables

Table 1: ECR – physical features .....	21
Table 2: ECR – technological features .....	22
Table 3: ECR – connections, display and control elements at the top .....	23
Table 4: ECR – connections, display and control elements at the bottom .....	24
Table 5: ECR – meaning of the display elements .....	25
Table 6: Blinking code of the signal LED .....	25
Table 7: ECR – description of the functions and meaning of the control elements ..	25
Table 8: ECR – power supply connections .....	26
Table 9: ECR – I/O interface connections .....	26
Table 10: ECR – RS232 interface connections .....	27
Table 11: Description of the pin allocation of the RS485 interface .....	27
Table 12: Permissible wire cross-sections for connectors .....	28
Table 13: Permissible line lengths .....	28

### 16.2 List of Diagrams

Figure 1: ECR – connections, display and control elements at the top .....	23
Figure 2: ECR – connections, display and control elements at the bottom .....	23
Figure 3: ECR – connections, display and control elements at the front .....	24
Figure 4: ECR – power supply connection .....	26
Figure 5: ECR – I/O interface connection .....	26
Figure 6: ECR – RS232 interface connection .....	27
Figure 7: ECR – RS485 interface connection .....	27
Figure 8: Principle circuit diagram of the RS485 interface .....	28
Figure 9: Profile handling – activating configuration modifications .....	40
Figure 10: Profile handling – scheme .....	42

# 17 Index

Access Point Name .....	47	General safety instructions .....	13
Accessories.....	19	GPRS.....	47
Additional information .....	8	Ground.....	26
Alternative results.....	8	GSM .....	48
APN.....	47	Housing .....	14
Assembly.....	29	HTTPS.....	38
AT command .....	47	Humidity .....	21
Blinking interval LED signal.....	25	I/O interface .....	23
Breakdown.....	9	ICMP .....	48
Broadcast.....	47	Intended Use.....	9
Caller ID.....	47	Interface.....	14, 48
Cellular antenna .....	23, 33	IP address .....	34, 48
CHAP.....	47	IP network.....	48
Checkmark.....	8	IP rating .....	21
CLI .....	36	ISP.....	48
Client.....	47	Key word .....	7
CLIP.....	47	LAN .....	48
Command line.....	36	LAN interface .....	48
Configuration .....	35, 36	Liquids.....	13, 29
Defects liability terms .....	6	MAC address.....	48
DFÜ.....	47	Marking .....	7
DHCP .....	47	Menu .....	37
Digital input .....	26	Modification .....	14, 43
Digital output .....	26	Moisture .....	13, 29
DIN rail.....	31	MSN .....	48
DNS.....	47	Net address.....	48
Domain name.....	47	Netmask .....	48
EDGE.....	47	Network card .....	34
Electrical installation.....	12	Network patch cable.....	34
Environment .....	13, 29	Network rules.....	48
Environmental Protection .....	11	Open Source .....	15
Ethernet.....	22	Operating voltage .....	21
Ethernet port.....	24	Operation.....	36
Explosive atmosphere.....	9	Output power .....	21
Firewall.....	47	Overvoltage.....	14
Formatting .....	8	Overvoltage protection.....	14
Gateway .....	47	PAP .....	48

Password .....	35, 36	Service Center Number .....	49
PC .....	34	Short-cut .....	14, 43
Permissible limit .....	10	Signal LED .....	25
Personnel .....	10	SIM card .....	33
PIN .....	33	SIM card reader .....	22, 23
Port .....	48	SMS .....	49
Port forwarding .....	48	Socket .....	49
Power consumption .....	21	Storage .....	10
Power LED .....	25	Switch .....	49
Power supply .....	23, 26, 34	Switch cabinet .....	31
PPP .....	49	Symbol .....	7, 8
PPPoE .....	49	TCP .....	49
Preface .....	6	Transport .....	10
Prerequisites .....	8	UDP .....	49
Qualification .....	10	UMTS .....	49
Recycling .....	44	URL .....	49
Removal .....	29	Usage .....	9
Repair .....	14, 43	User name .....	35, 36
Repurchasing .....	44	VPN .....	50
Reset key .....	23, 25	WAN .....	50
Responsibilities of the operator .....	10	WAN chain .....	50
Router .....	49	WAN group .....	50
RS232 .....	22	WAN interface .....	50
RS485 .....	22	WAN LED .....	25
Safety .....	9	Water spray .....	13, 29
SCN .....	49	Web interface .....	36, 38
Scope of Delivery .....	19	Wiring .....	29
Server .....	49	WLAN antenna .....	24

